

# CATALOGO DE HERRAJES



TNN

SALFORD®

INDUMA

FastCap®



Distribuidores autorizados a nivel nacional

TNN SALFORD INDUMA FORTLEV KÖRN  
EPEM MEINHAUS reel TRAME KRONA

# ÍNDICE

GARRUCHA INDUSTRIAL	3	BISAGRA VAIVÉN PARA PISO	25	ÁNGULO PARA CAMA	36
GARRUCHA CAUCHO INDUSTRIAL GIRATORIA	3	BISAGRA OMEGA	25	PASADOR CUADRADO	36
GARRUCHA CAUCHO INDUSTRIAL FIJA	3	BISAGRA DE MUEBLE	26	PASADOR ALEMÁN	37
GARRUCHA CAUCHO INDUSTRIAL GIRATORIA/FRENO	3	BISAGRA OMEGA ACERO INOX. RULIMÁN	26	PASADOR SUECO	37
GARRUCHA PVC NARANJA	4	BISAGRA NUDO ACERO INOX RULIMÁN	26	BASES	37
GARRUCHA PLATAFORMA	5	BISAGRA VAIVEN	26	BASE METÁLICA MESA	38
GARRUCHA DE BOLA PLATAFORMA	5	BISAGRA NUDO C.P. EMPAQUE TRÍO	27	BASE DE ACERO NEUMÁTICA SOFA CAMA	39
ROLLOS DE CANTOS PVC METRAJES	6	BISAGRA OMEGA MUEBLE	27	PLATINA	39
CANTO PVC	6	BISAGRA OMEGA IN	27	PIE DE AMIGO PLÁSTICO	39
PERFIL GOLA	9	BISAGRA PARA PUERTA	27	KIT DE MARQUETERÍA SOP	39
PERFIL LISTELO	11	BISAGRA OMEGA IN EMPAQUE TRÍO	28	PICAPORTE UÑA ACERO INOXIDABLE	39
TAPA ADHESIVAS PARA TORNILLOS	12	BISAGRA PRESIÓN	28	PORTACANDADO	40
TIRADERAS	13	BISAGRA PARA PUERTA RULIMÁN	28	ESCUADRA	40
TIRADERA INTEGRAL ALUMINIO	13	BISAGRA NUDO	28	SOPORTE DE EXHIBICIÓN DE BOLAS	41
PERFIL MARCO PUERTA ANAQUEL	13	BISAGRA REFORZADA HIERRO	28	SOPORTE GRADUADO	41
PERFIL LISTELO DECORATIVO EN T	13	BISAGRA PARA PUERTA RULIMÁN	29	PILAR RANURADO SIMPLE	41
ACCESORIO UNIÓN DE PERFIL	13	BISAGRA EN T	29	GANCHO DE EXHIBICIÓN	42
TIRA CAUCHO PERFIL GOLA	14	BISAGRA LARGA	29	SOPORTE MULTIUSOS METÁLICO	42
PROTECTOR TRANSPARENTE TABLERO PISO	14	BISAGRA DE PRESIÓN TAIWAN	30	SOPORTE ANAQUEL PARED	42
PERFIL GOLA AÉREO	14	BISAGRA TIPO PIANO	30	SOPORTE TUBO	42
PERFIL MARCO PUERTA ANAQUEL 1072	14	BISAGRA INVISIBLE	30	SOPORTE TUBO OVAL PLÁSTICO	43
PERFIL ALUMINIO RECTANGULAR	14	BISAGRA CIERRE LENTO RECTA TNN	31	SOPORTE CENTRAL TUBO OVALADO	43
RIEL PUERTA PLEGABLE LADO SUPERIOR	14	BISAGRA CIERRE LENTO SEMICODO TNN	31	TUBO CLOSET ABATIBLE	43
RIEL PUERTA CORREDIZA ALUMINIO	15	BISAGRA SEMICODO TNN	31	TUBO METÁLICO PARA CLOSET	44
RIEL PUERTA PLEGABLE LADO INFERIOR	15	BISAGRA RECTA TNN	31	TUBO ALUMINIO PARA CLOSET	44
RIEL PARA VITRINA O PUERTA CORREDIZA	15	BISAGRA SEMICODO SOFT CLOSE - CLIP ON	31	TUBO CORTINA ALUMINIO	44
RODACHINA PARA RIEL	15	BISAGRA RECTA SOFT CLOSE CLIP ON	31	ACCESORIOS DE CORTINAS	45
PIE DE MUEBLE	16	BISAGRA CODO	31	BASTON PARA CORTINERO	46
PIE REGULABLE	18	BISAGRA RECTA PARA ANAQUEL	32	SOPORTE OCULTO	46
RIELES	18	BISAGRA RECTA SALFORD	32	SOPORTE CPU COMPUTADOR	47
RIEL DE EXTENSIÓN 45 MM TNN	18	SET BISAGRA Y TOPE DE PRESIÓN	32	SOPORTE DE RÓTULO	47
RIEL EXTENSIÓN SOFT CLOSE TNN	18	BISAGRA DE 175G RECTA	33	SOPORTE REPISA	48
RIEL DE EXTENSIÓN PUSH TO OPEN TNN	19	BISAGRA DE 175G CODO	33	AVENTO	49
RIEL LIVIANA	19	BISAGRA 165G RECTA SOFT CLOSE	33	SOPORTE REPISA VIDRIO	49
RIEL AÉREO TNN	19	BISAGRA DE 90G ANAQUEL	33	CONECTOR DE ESCRITORIO	50
RIEL OCULTO SIST. PUSH TO OPEN	19	BISAGRA DE 135G ANAQUEL	34	CONECTOR MINIFIX EXCENTRICO	50
RIEL EXTENSIÓN OCULTA	19	BISAGRA CODO 270G ANAQUEL	34	CONECTOR PLÁSTICO TORNILLO	50
RIEL OCULTO PESADO SOFT CLOSE	19	BISAGRA MAQ. PESADA	34	BANDEJA PLÁSTICA VENTILACIÓN	50
RIEL EXTENSIÓN SALFORD	20	BISAGRA INVISIBLE AJUSTABLE	34	RUEDA PUERTA CORREDIZA TNN	50
RIEL PARA CAJÓN TNN	20	BISAGRA AEREA AJUSTABLE 3D	34	GANCHO COLGAR ROPA	51
CAJON METÁLICO TNN	21	BISAGRA DE MÁQUINA	34	TORNILLO MINI FIX	51
TORNILLO Y REMACHE	22	BISAGRA PARA VIDRIO	35	PIN DE MADERA	51
BISAGRAS	25	ESQUINA UNIÓN PARA ZÓCALO PVC 90G	35	TOPES	52
BISAGRA PIVOTE	25	UNION 180G PVC PARA ZOCALO	35	SET SISTEMA PUERTA CORREDIZA	53
BISAGRA COMUN	25	UNIÓN MOVIBLE PARA ZÓCALO PVC	35	RESBALÓN	53
BISAGRA PISTÓN 3 CUERPO INDUMA	25	ZÓCALO PVC ANAQUEL COCINA	35	PIVOT OCULTO PARA PUERTA	54
BISAGRA PISTÓN	25	GRAPA CAMA	36	ACCESORIO	54

### GARRUCHA CAUCHO INDUSTRIAL GIRATORIA

MEDIDAS	UNDS/ CARTON
3"	60
4"	38
5"	100
6"	150



Icon 1	Icon 2	Icon 3	Icon 4	Icon 5	Icon 6	Icon 7
9998940	18075	3"	22mm	75mm	81x67	35kg
9998941	18100	4"	30mm	100mm	100x80	55kg
9998942	18125	5"	34mm	125mm	100x80	95kg
9998943	18160	6"	39mm	150mm	135x105	115kg

### GARRUCHA CAUCHO INDUSTRIAL FIJA

MEDIDAS	UNDS/ CARTON
3"	60
4"	38
5"	28
6"	12



Icon 1	Icon 2	Icon 3	Icon 4	Icon 5	Icon 6	Icon 7
9998944	18075F	3"	22mm	75mm	81x67	35kg
9998945	18100F	4"	30mm	100mm	100x80	55kg
9998946	18125F	5"	34mm	125mm	100x80	95kg
9998947	18160F	6"	39mm	150mm	135x105	115kg

### GARRUCHA CAUCHO INDUSTRIAL GIRATORIA/FRENO

MEDIDAS	UNDS/ CARTON
3"	60
4"	32
5"	24
6"	12



Icon 1	Icon 2	Icon 3	Icon 4	Icon 5	Icon 6	Icon 7
9998948	18075B	3"	22mm	75mm	81x67	35kg
9998949	18100B	4"	30mm	100mm	100x80	55kg
9998950	181250B	5"	34mm	125mm	100x80	95kg
9998951	18160B	6"	39mm	150mm	135x105	115kg

# GARRUCHA INDUSTRIAL



Todas las imágenes son referenciales al producto original



**GARRUCHA PVC NARANJA FIJA**



MEDIDAS	UNDS/ CARTON
1 1/2"	150
2"	100

Icon 1	Icon 2	Icon 3	Icon 4	Icon 5	Icon 6	Icon 7
9998954	26040F	1 1/2"	21mm	40mm	60x43	30kg
9998955	26050F	2"	24mm	50mm	70x51	40kg

**GARRUCHA PVC NARANJA GIRATORIA**



MEDIDAS	UNDS/ CARTON
1 1/2"	150
2"	100

Icon 1	Icon 2	Icon 3	Icon 4	Icon 5	Icon 6	Icon 7
9998952	26040	1 1/2"	21mm	40mm	60x43	30kg
9998953	26050	2"	24mm	50mm	70x51	40kg

**GARRUCHA PVC NARANJA GIRATORIA/FRENO**

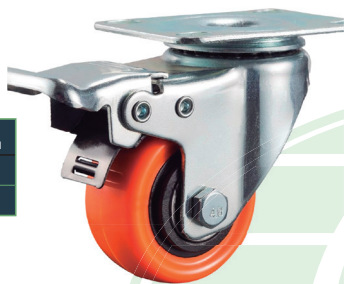

MEDIDAS	UNDS/ CARTON
1 1/2"	120
2"	80

Icon 1	Icon 2	Icon 3	Icon 4	Icon 5	Icon 6	Icon 7
9998956	26040B	1 1/2"	21mm	40mm	60x43	30kg
9998957	26050B	2"	24mm	50mm	70x51	40kg

**GARRUCHA PVC NARANJA FIJA**



MEDIDAS	UNDS/ CARTON
2.5"	40
3"	40
4"	30
5"	20

Icon 1	Icon 2	Icon 3	Icon 4	Icon 5	Icon 6	Icon 7
9998962	26065F	2.5"	31mm	65mm	94x63	80kg
9998963	26075F	3"	31mm	75mm	94x63	90kg
9998964	26100F	4"	31mm	100mm	94x63	100kg
9998965	26125F	5"	31mm	125mm	94x63	100kg

**GARRUCHA PVC NARANJA GIRATORIA/FRENO**



MEDIDAS	UNDS/ CARTON
2.5"	40
3"	40
4"	30
5"	20

Icon 1	Icon 2	Icon 3	Icon 4	Icon 5	Icon 6	Icon 7
9998966	26065B	2.5"	31mm	65mm	94x63	80kg
9998967	26075	3"	31mm	75mm	94x63	90kg
9998968	26100B	4"	31mm	100mm	94x63	100kg
9998969	26125B	5"	31mm	125mm	94x63	100kg

**GARRUCHA PVC NARANJA GIRATORIA**



MEDIDAS	UNDS/ CARTON
2.5"	40
3"	40
4"	30
5"	20

Icon 1	Icon 2	Icon 3	Icon 4	Icon 5	Icon 6	Icon 7
9998958	26065	2.5"	31mm	65mm	94x63	60kg
9998959	26075	3"	31mm	75mm	94x63	80kg
9998960	26100	4"	31mm	100mm	94x63	90kg
9998961	26125	5"	31mm	125mm	94x63	100kg

Todas las imágenes son referenciales al producto original

GARRUCHA PLATAFORMA



GARRUCHA DE BOLA PLATAFORMA

Código 1	Medidas
62199	1,5"
621991	2"



GARRUCHA PLATAFORMA CON FRENO

Código 1	Código 2	Medidas
621981	TWPB-40	1,5"
621983	TWPB-50	2"



GARRUCHA PLATAFORMA SIN FRENO

Código 1	Código 2	Medidas
621980	TWP-40	1,5"
621982	TWP-50	2"



GARRUCHA PLATAFORMA

Código 1	Código 2	Medidas
621992	ICP-40	1,5"
621993	ICP-50	2"



GARRUCHA DE ESPIGA

Código 1	Código 2	Medidas
62198	TWRS-50	2"

Todas las imágenes son referenciales al producto original

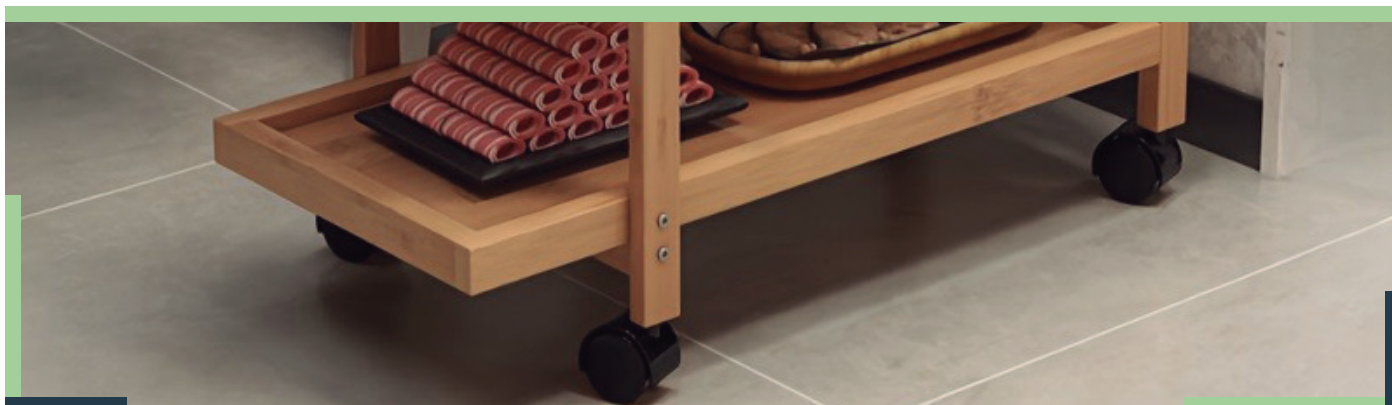



Detalles que protegen y embellecen:  
resistencia y estilo en cada borde.

# CANTOS PVC

Todas las imágenes son referenciales al producto original

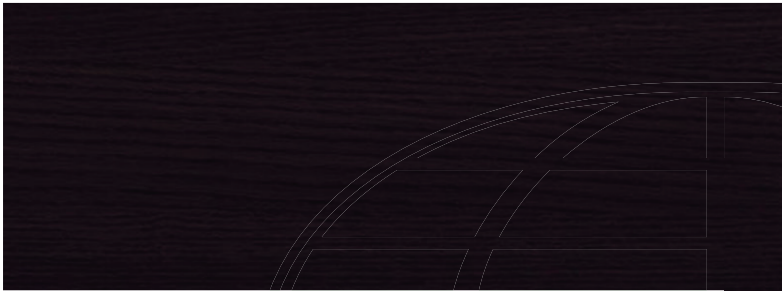

CANTO PVC WENGUE		
Código 1	Código 2	Medidas
99938	TH2060	18X0.45MMX200M
99953	TH2060	28X1.5MMX100M
9994402	CANTO	21X0.45MMX200M
9995907	4121	22X2MMX100MM
99959102	CANTO	40X0.45MMX200M



CANTO PVC BLANCO		
Código 1	Código 2	Medidas
99937	CANTO	18X0.45MMX200M
9994401	CANTO	21X0.45MMX200M
99959101	CANTO	40X0.45MMX200M

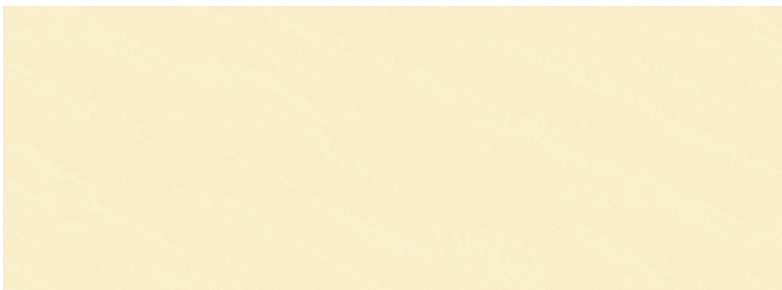

CANTO PVC ALMENDRA		
Código 1	Código 2	Medidas
99939	T009	18X0.40MMX200M
99947	T009	22X0.45MMX200M

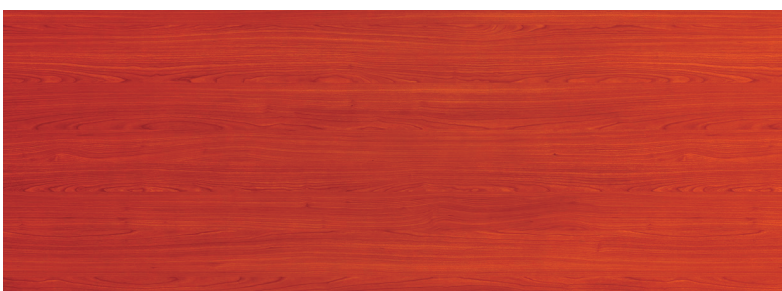

CANTO PVC CEREZO		
Código 1	Código 2	Medidas
99941	814	18X0.40MMX200M
99949	814	22X0.45MMX200M
99955	814	28X1.5MMX100M
9995908	814	22X2MMX100M

# CATÁLOGO DE PRODUCTOS HERRAJES



CANTO PVC ABEDUL		
Código 1	Código 2	Medidas
99942	TH2046	18X0.40X200M
99950	TH2046	22X0.45MMX200M
99956	TH2046	28X1.5MMX100M

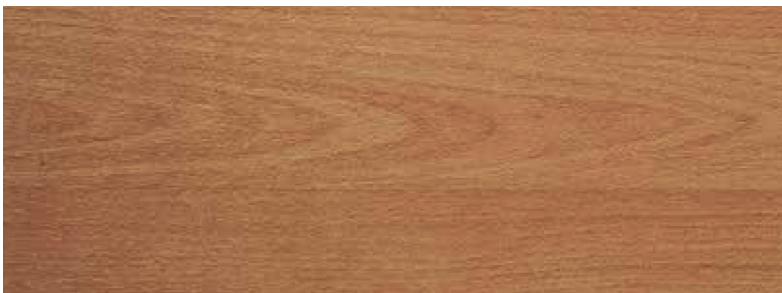

CANTO PVC HAYA		
Código 1	Código 2	Medidas
99943	TH2027	18X0.40MMX200M
9995904	818	22X0.40MMX200M
99951	818	22X0.45MMX200M
99957	818	28X1.5MMX100M



CANTO PVC NEGRO		
Código 1	Código 2	Medidas
99940	CANTO PVC	18X0.45MMX200M
99948	2001	22X0.45MMX200M
99954	2001	28X1.5MMX100M
9995901	2001	22X0.40MMX200M
9994405	CANTO PVC	21X0.45MMX200M
9995906	2001	22X2MMX100M
99959105	CANTO PVC	40X0.45MMX200M



CANTO PVC SAPELLI		
Código 1	Código 2	Medidas
99944	TH2034	18X0.40MMX200M
99952	825	22X0.45MMX200M
99958	TH2034	28X1.5MMX100M
9994410	CANTO PVC	21X0.45MMX200M
9995905	825	22X0.40MMX200M
9995910	4892	22X2MMX100M



CANTO PVC CARAMELO		
Código 1	Código 2	Medidas
9994403	CANTO PVC	21X0.45MMX200M
99959103	CANTO PVC	40X0.45MMX200M

Todas las imágenes son referenciales al producto original



CANTO PVC DUNA		
Código 1	Código 2	Medidas
9994404	CANTO PVC	21X0.45MMX200M
99959104	CANTO PVC	40X0.40MMX200M

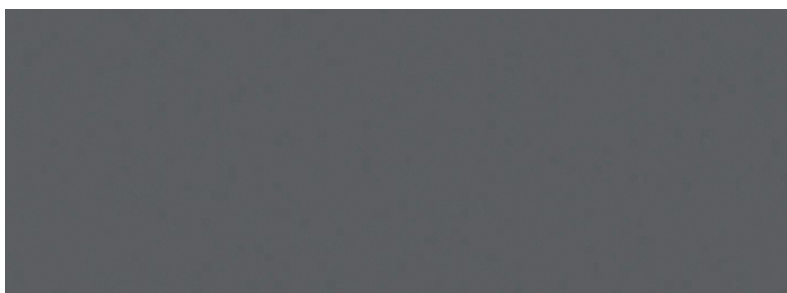

CANTO PVC PLOMO		
Código 1	Código 2	Medidas
9994406	CANTO PVC	21X0.45MMX200M
99959106	CANTO PVC	40X0.45MMX200M



CANTO PVC ROVERE		
Código 1	Código 2	Medidas
9994407	CANTO PVC	21X0.45MMX200M
99959107	CANTO PVC	40X0.45X200M



CANTO PVC GALES		
Código 1	Código 2	Medidas
9994408	CANTO PVC	21X0.45MMX200M
99959108	CANTO PVC	40X0.45MMX200M



CANTO PVC CONIAC		
Código 1	Código 2	Medidas
9994409	CANTO PVC	21X0.45MMX200M
99959109	CANTO PVC	40X0.45MMX200M

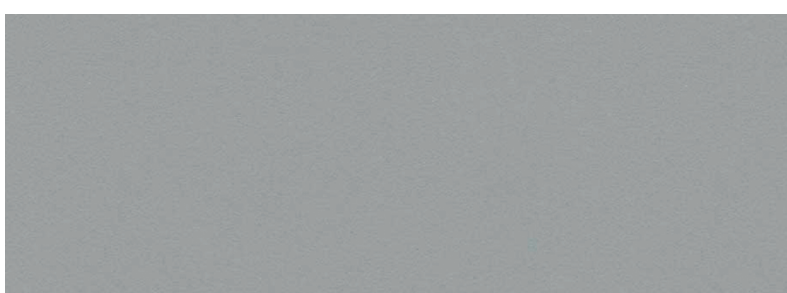

CANTO PVC ALUMINIO		
Código 1	Código 2	Medidas
99959	816	28X1.5MMX100M

Todas las imágenes son referenciales al producto original

PERFIL GOLA TIPO J GYC J-0119 3M

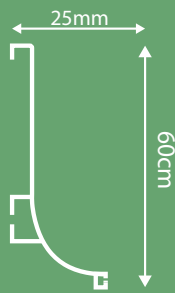

NEGRO MATE

621694510



BRONCE ANTICUO

6216945101



SILVER

62169451

📞 0997896093

✉ info@cedimportsa.com

✉ ventas@cedimportsa.com

📍 Parque Industrial Inmaconsa Calle A sn y Tecas



**PERFIL GOLA TIPO C GYC 1882 3M**

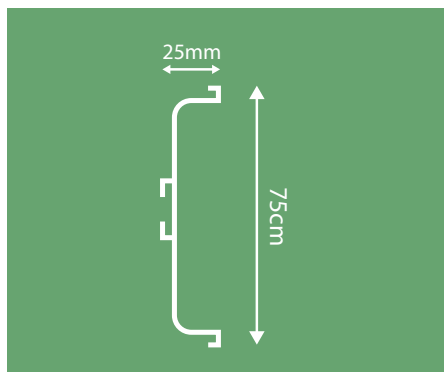

**NEGRO**

97529048

**BRONCE ANTIGUO**

6216945102

**SILVER**

97529049

**PERFIL GOLA TIPO L GYC 1883 3M**

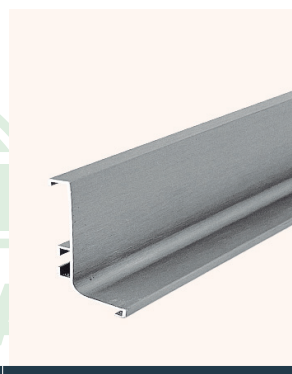
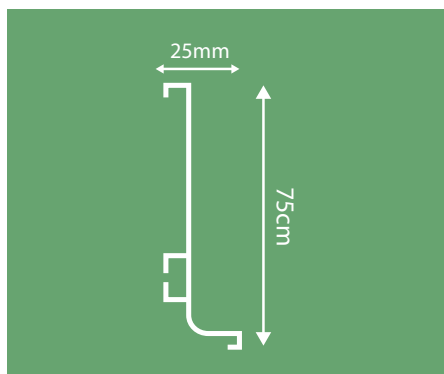

**NEGRO**

97529046

**BRONCE ANTIGUO**

975290471

**SILVER**

97529047

**PERFIL GOLA TIPO C GYC 0117 3M**

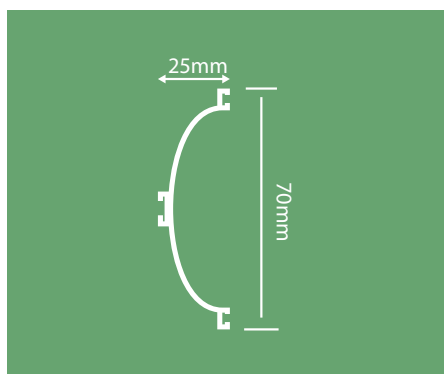

**NEGRO MATE**

621694500

**BRONCE ANTIGUO**

621694501

**SILVER**

62169450

Todas las imágenes son referenciales al producto original

PERFIL GOLA LED TIPO C GYC-2979 3M

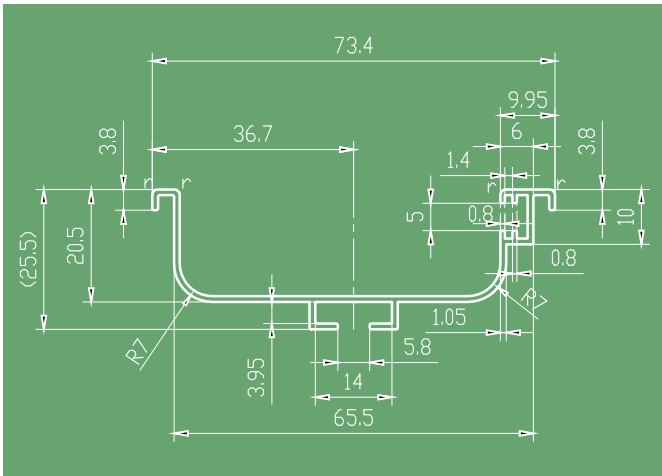

NEGRO MATE	SILVER
6216945104	6216945103

PERFIL GOLA LED TIPO L GYC-2980 3M

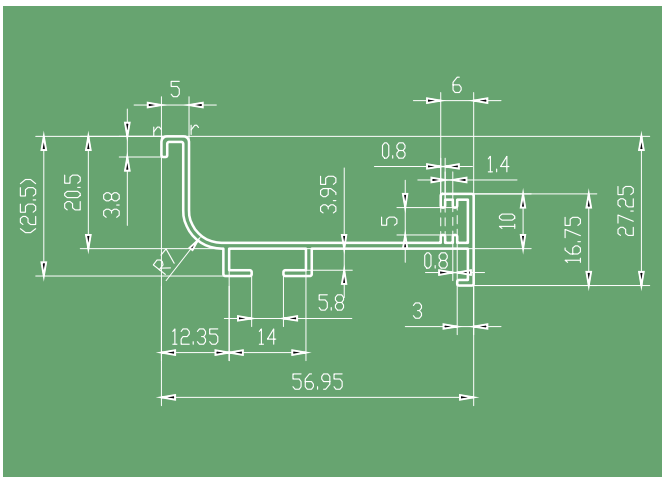

NEGRO MATE	SILVER
6216945106	6216945105

PERFIL GOLA LED TIPO J GYC-2982 3M

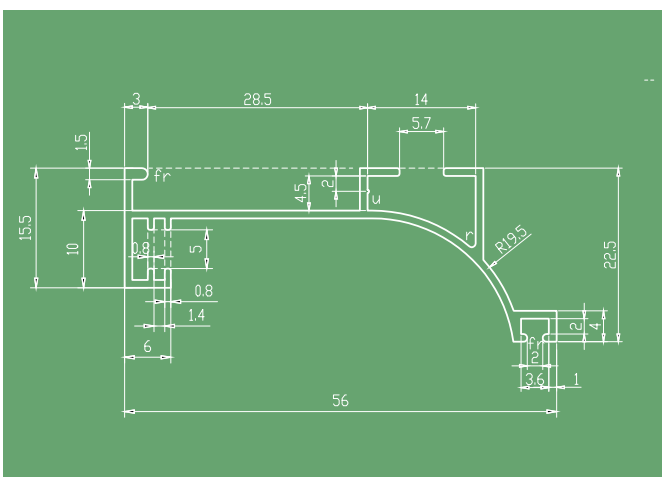

NEGRO MATE	SILVER
6216945108	6216945107

Todas las imágenes son referenciales al producto original

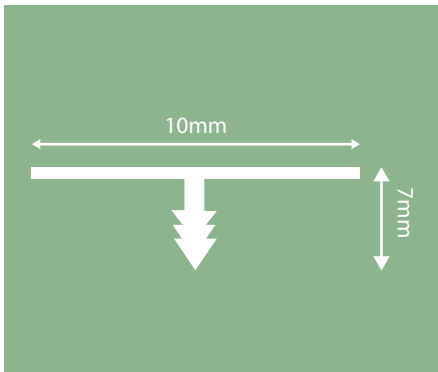

## PERFIL LISTELO T GYCT - 0900

**Medidas:10X7MMX3M****DORADO MATE**

621694902

**SILVER**

62169490

**NEGRO MATE**

621694904

## PERFIL LISTELO T GYCT - 02010

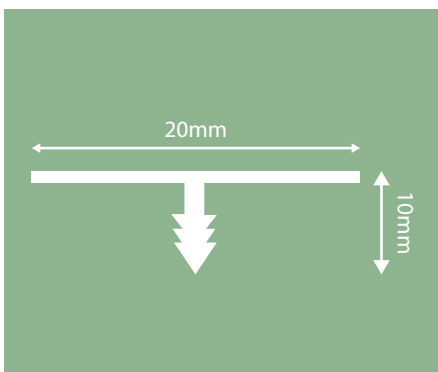
**Medidas:20X7MMX3M****DORADO MATE**

621694903

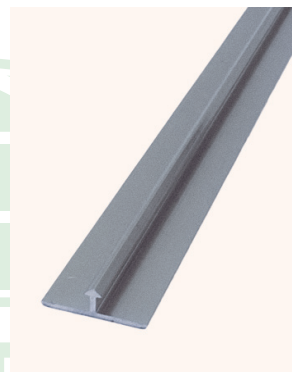
**SILVER**

621694901

**NEGRO MATE**

621694905

Los perfiles listelo son elementos decorativos y funcionales utilizados en revestimientos de paredes y pisos, especialmente en cerámica, porcelanato y puertas modernas. Se presentan en materiales como aluminio, acero inoxidable sirven para:

**Delimitar espacios en cerámicas**

**Brindar un acabado elegante**

**Proteger bordes**

**Crear transiciones armoniosas**

**Perfil decorativo en muebles de madera**

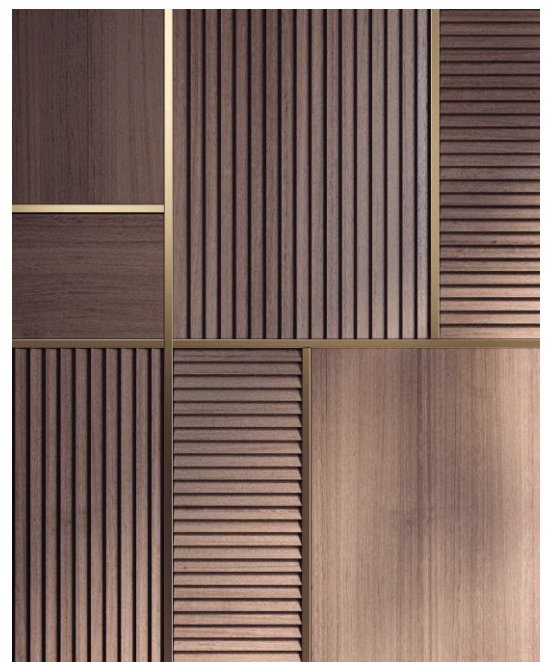

Todas las imágenes son referenciales al producto original

## TAPA ADHESIVAS PARA TORNILLOS

ALMENDRA

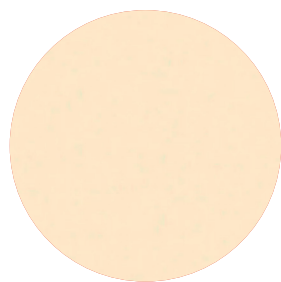

Código	Color	Cartón
941	Almendro	500U

NEGRO



Código	Color	Cartón
942	Negro	500U

CEREZO



Código	Color	Cartón
944	Cerezo	500U

HAYA



Código	Color	Cartón
945	Haya	500U

CROMADO

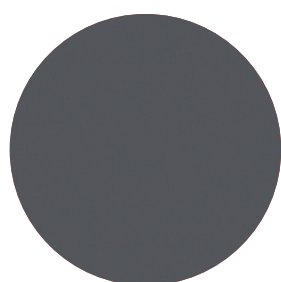

Código	Color	Cartón
946	Cromado	500U

NOGAL



Código	Color	Cartón
951	Nogal	500U

WENGUE

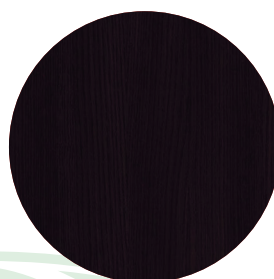

Código	Color	Cartón
943	Wengue	500U

HAYA CATEDRAL



Código	Color	Cartón
949	Catedral	500U

MAPLE



Código	Color	Cartón
950	Maple	500U

ROBLE



Código	Color	Cartón
952	RN	500U

BLANCO



Código	Color	Cartón
940	White	500U

SAPELLI



Código	Color	Cartón
947	MC	500U

BLANCO

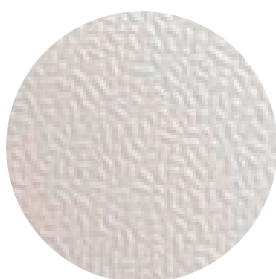

Código	Color	Medida	Cartón
999371	BLANCO	0,4X14MM	500U

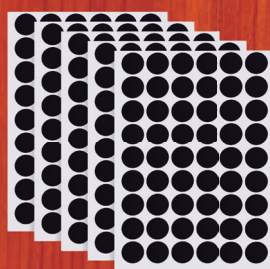

**FastCap**®

## EMPAQUE

Las tapas para tornillos son accesorios diseñados para cubrir y proteger la cabeza de los tornillos, mejorando la estética y ofreciendo una mayor seguridad en las instalaciones. Se utilizan en muebles, carpintería, estructuras metálicas y otros acabados para lograr un aspecto limpio y uniforme. Además, ayudan a prevenir el desgaste por exposición a humedad, polvo y otros factores ambientales.

Todas las imágenes son referenciales al producto original

TIRADERAS, PERFILES Y RIELES

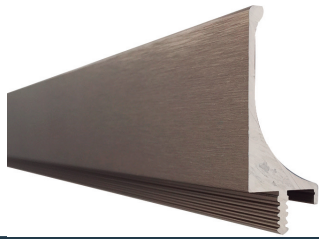

TIRADERA INTEGRAL ALUMINIO

Código 1	Código 2	Medidas
6216490	EAPS009	3 M



TIRADERA INTEGRAL ALUMINIO

Código 1	Código 2	Medidas
6216491	Z023	3 M

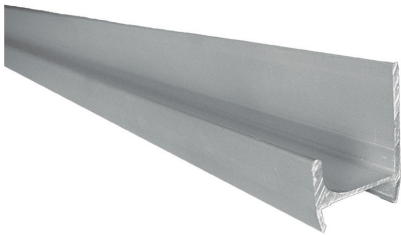

TIRADERA INTEGRAL ALUMINIO

Código 1	Código 2	Medidas
6216492	GYC-0388	3 M

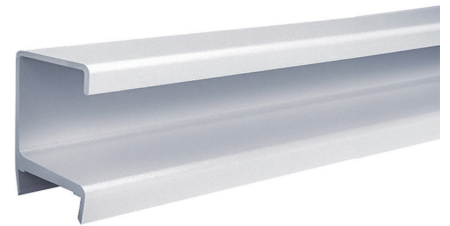

TIRADERA INTEGRAL ALUMINIO

Código 1	Código 2	Medidas
62169448	CSA004	3 M
621694480	CSA004	3 M

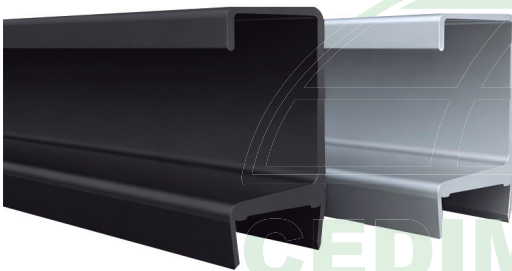

TIRADERA INTEGRAL ALUMINIO

Código 1	Código 2	Medidas
621694481	GYC-1138	3 M
621694482	GYC-1138	3 M

GEDIMPORTSA S.A.

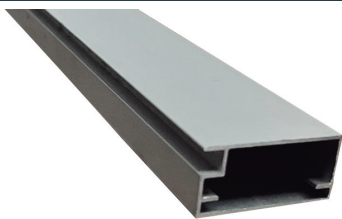

PERFIL MARCO PUERTA ANAQUEL

Código 1	Código 2	Medidas
62169447	CSA003	3 M



TIRADERA INTEGRAL ALUMINIO

Código 1	Código 2	Medidas	Color
6216493	GYC-0388	3 M	Negro

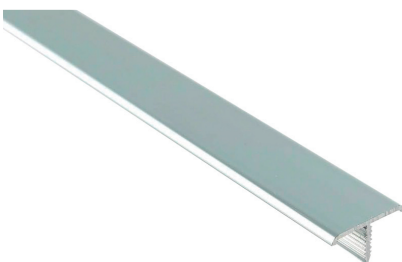

PERFIL LISTELO DECORATIVO EN T

Código 1	Código 2	Medidas
62169490	GYC-0900	10X7MM X 3MM

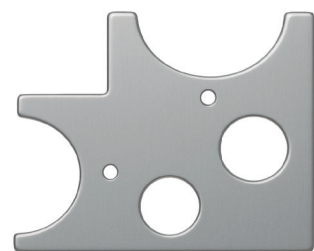

ACCESORIO UNIÓN DE PERFIL

Código 1	Código 2	Medidas
62169449	CSA005	60 X 60 MM

Todas las imágenes son referenciales al producto original



ACCESORIO METALICO UNION PERFIL			
Código 1	Código 2	Color	
621694491	GY-BT65	Metal	



TIRA CAUCHO PERFIL GOLA		
Código 1	Código 2	Medidas
97529023	AP.5000	3M



PROTECTOR TRANSPARENTE TABLERO PISO	
EMPAQUE POR UNIDAD	
Código 1	Medidas
999368	15MMX2M
999369	15MMX3M

Todas las imágenes son referenciales al producto original

PERFIL GOLA AÉREO

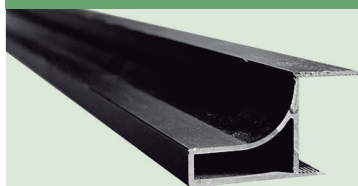

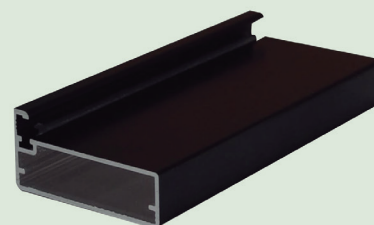

EMPAQUE POR 10 UNIDADES				
Código 1	Código 2	Medidas	Color	
621694514	GYC-0971	3 M	Negro mate	

PERFIL MARCO PUERTA ANAQUEL 1072

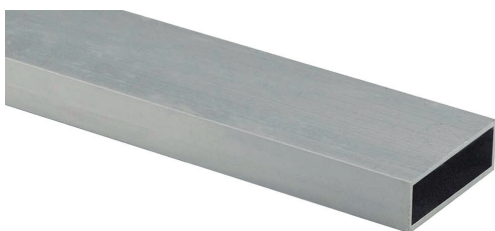

EMPAQUE POR 10 UNIDADES				
Código 1	Código 2	Medidas	Color	
621694471	GYC-1072	3 M	Silver	
621694472	GYC-1072	3 M	Negro	



PERFIL ALUMINIO RECTANGULAR				
EMPAQUE POR 10 UNIDADES				
Código 1	Código 2	Medidas	Color	
62169491	G7638A	1X76.2X6M	Aluminio	



RIEL PUERTA PLEGABLE LADO SUPERIOR				
EMPAQUE POR 40 UNIDADES				
Código 1	Código 2	Medidas	Color	
97529004	FW.9710	3 M	Zincado	

CATÁLOGO DE PRODUCTOS HERRAJES



RIEL PUERTA CORREDIZA ALUMINIO - PARA RUEDA RSD10				
EMPAQUE POR 6 UNIDADES				
Código 1	Código 2	Medidas	Color	
6216943	GYC507	2 M	Silver	
6216944	GYC507	3 M	Silver	



RIEL PUERTA CORREDIZA ALUMINIO - PARA RUEDA RSD20 - RSD30				
EMPAQUE POR 10 UNIDADES				
Código 1	Código 2	Medidas	Color	
6216948	GYC508	2 M	Aluminio	
6216949	GYC508	3 M	Aluminio	

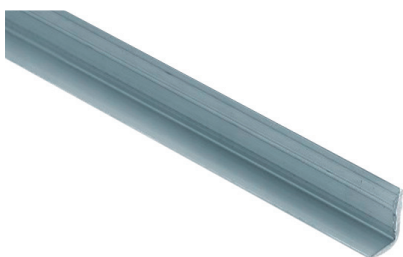

RIEL PUERTA PLEGABLE LADO INFERIOR				
EMPAQUE POR 40 UNIDADES				
Código 1	Código 2	Medidas	Color	
97529005	FW.9720	3 M	Zincado	

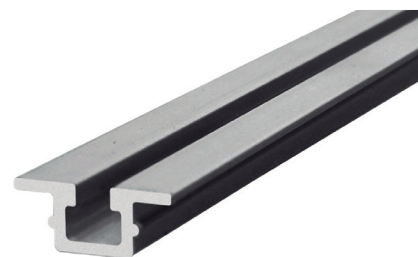

RIEL PUERTA CORREDIZA CSA002				
Código 1	Medidas	Color		
62169445	2 M	Aluminio		
62169446	3 M	Aluminio		

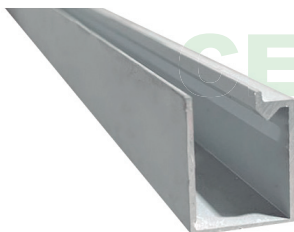

RIEL PUERTA CORREDIZA				
Código 1	Código 2	Medidas	Color	
62169443	CSA001	2 M	Aluminio	
62169444	CSA001	3 M	Aluminio	

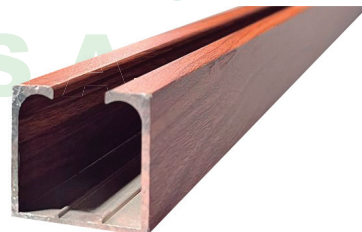

RIEL PUERTA CORREDIZA ALUMINIO - PARA RUEDA RSD10				
Código 1	Código 2	Medidas	Color	
62169430	GYC507	2 M	Wood	
62169431	GYC507	3 M	Wood	

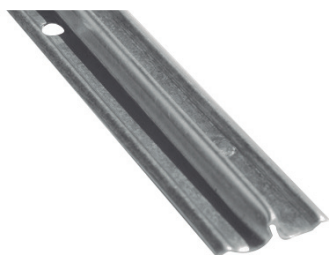

RIEL PARA VITRINA O PUERTA CORREDIZA				
Código 1	Medidas	Color		
164	2 M	Hierro		
165	3 M	Hierro		



RODACHINA PARA RIEL				
Código 1	Color			
163	SN			

Todas las imágenes son referenciales al producto original



PIE DE MUEBLE				
Código 1	Código 2	Medidas	Color	
621714	Z225	120 MM	CP	
621715	Z225	120 MM	SN	



PIE DE MUEBLE				
Código 1	Código 2	Medidas	Color	
621716	Z227	90 MM	CP	
621718	CZ239	130 MM	CP	
621719	CZ239	130 MM	SN	



PIE DE MUEBLE				
Código 1	Código 2	Medidas	Color	
621722	Z242	140 MM	CP	



PIE DE MUEBLE				
Código 1	Código 2	Medidas	Color	
621729	S301-3	120 MM	CP	
621726	S301-1	105 MM	CP	



PIE DE MUEBLE				
Código 1	Código 2	Medidas	Color	
621707	Z208	130 MM	CP	
621708	Z208	130 MM	SN	





PIE DE MUEBLE				
Código 1	Código 2	Medidas	Color	
621703	A102	50X150MM	CP	





Todas las imágenes son referenciales al producto original



PIE DE MUEBLE				
Código 1	Código 2	Medidas	Color	
621731	S318	130 MM	CP	
621732	S318	130 MM	SN	





PIE DE MUEBLE				
Código 1	Código 2	Medidas	Color	
621713	Z219	120 MM	CP	



PIE DE MUEBLE				
Código 1	Código 2	Medidas	Color	
621725	Z249	95MM	SP	



PIE DE MUEBLE				
Código 1	Código 2	Medidas	Color	
621706	Z201 - 4	120 MM	CP	

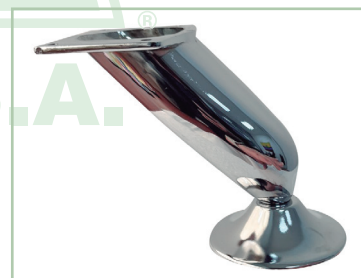

PIE DE MUEBLE				
Código 1	Código 2	Medidas	Color	
621742	S361	120MM	CP	



PIE DE MUEBLE				
Código 1	Código 2	Medidas	Color	
621730	S303	100MM	CP	



Todas las imágenes son referenciales al producto original

PIE DE MUEBLE



CAJA POR 10 UNIDADES

Código 1	Código 2	Medidas	Color
621697	FTR30B	30X100MM	CP
621698	FTR30B	30X150MM	CP

PIE DE MUEBLE



Código 1	Código 2	Medidas	Color
6217493	Z216	130 MM	CP
6217494	Z216	130 MM	SN

PIE DE MUEBLE AJUSTABLE



**NUEVO**

Código 1	Código 2	Medidas	Color
9995918201	SS201	50XH60MM	SS
9995918202	SS201	50XH80MM	SS
9995918203	SS201	50XH100MM	SS
9995918204	SS201	50XH120MM	SS
9995918205	SS201	50XH150MM	SS

PIE DE MUEBLE AJUSTABLE



**NUEVO**

Código 1	Código 2	Medidas	Color
9995918206	SS201	50XH60MM	MB
9995918207	SS201	50XH80MM	MB
9995918208	SS201	50XH100MM	MB
9995918209	SS201	50XH120MM	MB
9995918210	SS201	50XH150MM	MB

PIE REGULABLE



Código 1	Código 2	Medidas
62174995	KFT001-1	100-130MM
621749951	KFT001-3	120-150MM
62174996	KFT001-4	150-180

Todas las imágenes son referenciales al producto original

☎ 0997896093

✉ info@cedimportsa.com

✉ ventas@cedimportsa.com

📍 Parque Industrial Inmaconsa Calle A sn y Tecas

## RIELES



RIEL DE EXTENSIÓN 45 MM TNN				
Código 1	Código 2	Medidas	Color	
6151	4501	30 CM	Zincado	
6152	4501	35 CM	Zincado	
6153	4501	40 CM	Zincado	
6154	4501	45 CM	Zincado	
6155	4501	50 CM	Zincado	
6156	4501	55 CM	Zincado	
61561	4501	60 CM	Zincado	
6157	2701	40 CM	Zincado	



RIEL EXTENSIÓN SOFT CLOSE TNN		
Código 1	Código 2	Medidas
615617	4512A	30 CM
61562	4512A	35 CM
61563	4512A	40 CM
61564	4512A	45 CM
61565	4512A	50 CM
61566	4512A	55 CM
615650	4512A	60 CM

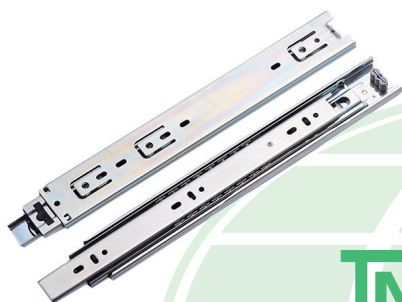

RIEL DE EXTENSIÓN PUSH TO OPEN TNN				
Código 1	Código 2	Medidas	Color	
615664	4513	30 CM	Zincado	
615665	4513	35 CM	Zincado	
615666	4513	40 CM	Zincado	
615660	4513T	45 CM	Zincado	
615661	4513T	50 CM	Zincado	
615662	4513	55 CM	Zincado	
615663	4513	60 CM	Zincado	

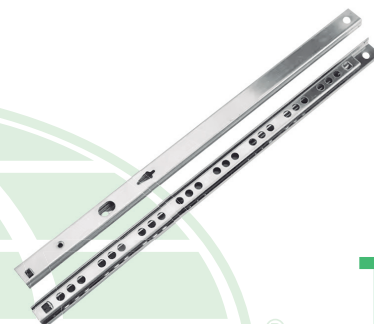

RIEL LIVIANA				
Código 1	Código 2	Medidas	Color	
6216945	1701C	246 MM	Zincado	
6216946	1701C	278 MM	Zincado	
6216947	1701C	310 MM	Zincado	
62169470	1701C	400 MM	Zincado	
62169471	1701C	450 MM	Zincado	



RIEL AÉREO TNN			
Código 1	Medidas	Color	
600	35 CM	Zincado	
6001	40 CM	Zincado	



RIEL OCULTO SIST. PUSH TO OPEN				
Código 1	Código 2	Medidas	Color	
62169474	A0715	450 MM	Zincado	
62169475	A0715	500 MM	Zincado	
62169476	A0715	550 MM	Zincado	

Todas las imágenes son referenciales al producto original



RIEL EXTENSIÓN OCULTA				
Código 1	Código 2	Medidas	Color	
6216940	3504(SL.4506)	400 MM	Zincado	
6216941	3504(SL.4506)	450 MM	Zincado	
6216942	3504(SL.4506)	500 MM	Zincado	



RIEL OCULTO PESADO SOFT CLOSE				
Código 1	Código 2	Medidas	Color	
62169472	3514C	450 MM	Zincado	
62169473	3514C	500 MM	Zincado	
621694730	3514C	550 MM	Zincado	

Todas las imágenes son referenciales al producto original



RIEL EXTENSIÓN SALFORD		
Código 1	Código 2	Medidas
615610	4501B	30 CM
615611	4501B	35 CM
615612	4501B	40 CM
615613	4501B	45 CM
615614	4501B	50 CM
615615	4501B	55 CM

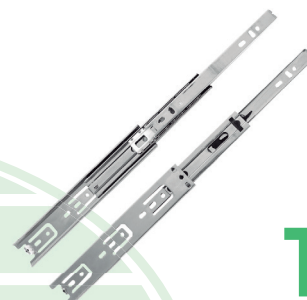

RIEL DE EXTENSIÓN 35 MM				
Código 1	Código 2	Medidas	Color	
61567	S3502	30 CM	Zincado	
61568	S3502	35 CM	Zincado	
61569	S3502	40 CM	Zincado	
615690	S3502	45 CM	Zincado	
615691	S3502	50 CM	Zincado	



RIEL OCULTO PUSH & SOFT CLOSE				
Código 1	Código 2	Medidas	Color	
621694710	3514AC-N	450 MM	Zincado	
621694711	3514AC-N	500 MM	Zincado	

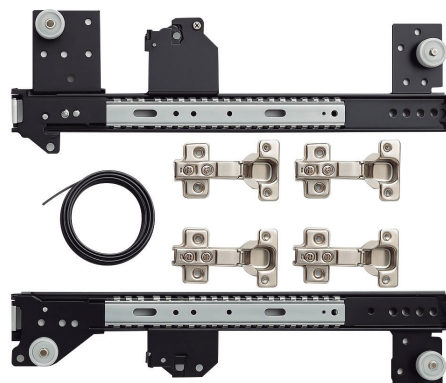

**NUEVO**



SISTEMA RIELES PUERTA OCULTAS LATERALES		
Código 1	Código 2	Medida
621694731	YF-SN-002-K	500MM

CATÁLOGO DE PRODUCTOS HERRAJES

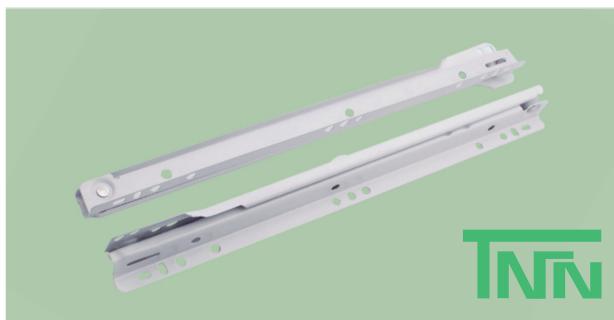

RIEL PARA CAJÓN CENTRAL TNN		
Código 1	Medidas	Color
621631	35 CM	Blanco
62161	40 CM	Blanco
62162	45 CM	Blanco
62163	50 CM	Blanco



RIEL CAJÓN LATERAL TNN			
Código 1	Medidas	Color	
616	30 CM	Blanco	
617	35 CM	Blanco	
618	40 CM	Blanco	
619	45 CM	Blanco	
620	50 CM	Blanco	
621	55 CM	Blanco	
6210	60 CM	Blanco	
6211	30 CM	Café	
6212	35 CM	Café	
6213	40 CM	Café	

RIEL CAJÓN LATERAL TNN			
Código 1	Medidas	Color	
6214	45 CM	Café	
6215	50 CM	Café	
6216	55 CM	Café	
62160	60 CM	Café	
62164	30 CM	Negro	
62165	35 CM	Negro	
62166	40 CM	Negro	
62167	45 CM	Negro	
62168	50 CM	Negro	
62169	55 CM	Negro	
621691	60 CM	Negro	



RIEL CAJÓN SALFORD			
Código 1	Medidas	Color	
62100	30 CM	Blanco	
62101	35 CM	Blanco	
62102	40 CM	Blanco	
62103	45 CM	Blanco	
62104	50 CM	Blanco	
62105	55 CM	Blanco	
62106	60 CM	Blanco	

CAJON METÁLICO TNN		
Código 1	Código 2	Medidas
621692	DS-012	45X12CM
621693	DS-012	50X12CM
6216930	DS-013	45X15CM
6216931	DS-013	50X15CM

Todas las imágenes son referenciales al producto original

# TORNILLO Y REMACHE

## TORNILLO CABEZA LENTEJA



### CAJA POR 1000 UNIDADES

Código 1	Medidas	Color	
5326	8X1"	Zincado	
5327	8X1 1/2"	Zincado	
5328	8X2"	Zincado	

## REMACHE POP - TIPO DOMO



### CAJA POR 1000 UNIDADES

Código 1	Medidas	Color	
43183	1/8"X1/2"	Blanco	
43184	5/32"X1/2"	Blanco	

# CATÁLOGO DE PRODUCTOS HERRAJES

## TORNILLO AUTORROSCANTE (BISAGRA TNN)



CAJA POR 1000 UNIDADES

Código 1	Medidas	Color	
6219960	MAX14MM	Zincado	

## TORNILLO AUTORROSCANTE ZINCADO (RIEL TNN)

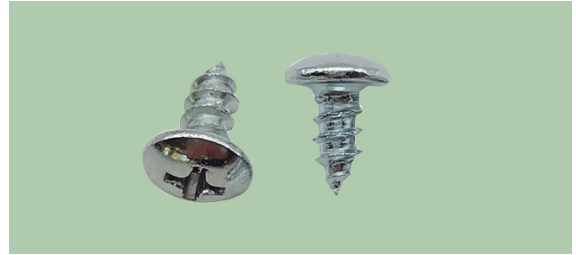

CAJA POR 1000 UNIDADES

Código 1	Medidas	Color	
6219961	M3.5X12MM	Zincado	

## TORNILLO MULTICORTE



Código 1	Medidas	Color	
850999142	4X45	Dorado	

## TORNILLO MINIFX



Código 1	Código 2
612009	EF1514-2

## REMACHE POP - TIPO DOMO COLOR NATURAL

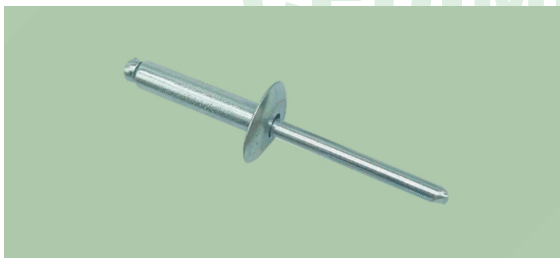

CAJA POR 100 UNIDADES

Código 1	Medidas	Color	
43173	1/8" X 1/2"	Zincado	
43174	5/32" X 3/8"	Zincado	
43175	5/32" X 1/2"	Zincado	
43176	3/16" X 1/2"	Zincado	
43177	3/16" X 1"	Zincado	

## REMACHE POP - TIPO DOMO



CAJA POR 100 UNIDADES

Código 1	Medidas	Color	
43178	1/8" X 1/2"	Negro	
43179	5/32" X 3/8"	Negro	
43180	5/32" X 1/2"	Negro	
43181	3/16" X 1/2"	Negro	
43182	3/16" X 1"	Negro	

Todas las imágenes son referenciales al producto original

 0997896093

 [info@cedimportsa.com](mailto:info@cedimportsa.com)

 [ventas@cedimportsa.com](mailto:ventas@cedimportsa.com)

 Parque Industrial Inmaconsa Calle A sn y Tecas





**CEDIMPORTSA S.A.**

**TORNILLO AUTORROSCANTE ROSCA GRUESA**



Código 1	Medidas	Código 1	Medidas
414	6X3/4	4221	7X2 1/2"
415	6X1	4222	7X2
416	6X1 1/4	423	8X1
4161	6X1 1/2	424	8X1 1/4
418	6X1 5/8	426	8X1 5/8
419	6X2	427	8X2
4190	6X2 1/2	428	8X2 1/2
4191	7X1	429	8X3
420	7X1 1/4	4291	10X3 1/2
4220	7X1 1/2		

**TORNILLO TRIPA DE PATO**



Código 1	Medidas	Código 1	Medidas
4293	6X3/8	4306	10X1/2
4294	6X1/2	4307	10X5/8
4295	6X5/8	4308	10X3/4
4296	6X3/4	4309	10X1
4297	6X1	4310	10X1 1/2
4298	8X3/8	4311	10X2
4299	8X1/2	4312	10X2 1/2
4300	8X5/8	4313	12X1 1/2
4301	8X3/4	4314	12X2
4302	8X1	4315	12X2 1/2
4303	8X1 1/2	4316	14X2
4304	8X2	4317	14X2 1/2
4305	8X2 1/2	42970	6X1 1/2

**TORNILLO PUNTA DE BROCA - CABEZA HEXAGONAL, CON ARANDELA**



Código 1	Medidas
43170	10X3/4
43171	10X1
43172	10X2
431720	12X1
431721	12X1 1/2
431722	12X2
431723	12X2 1/2

**TORNILLO AUTORROSCANTE ROSCA FINA PARA GYPSUM**

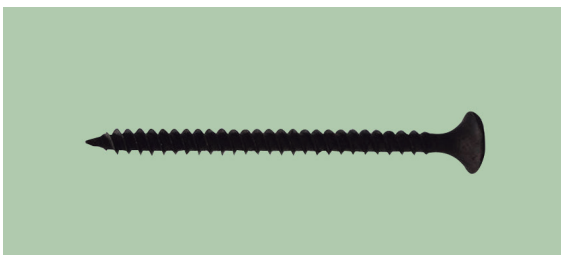

Código 1	Medidas	Color	
42920	6X1	Negro	
42921	6X1 1/4	Megro	

**TUERCA PARA TORNILLO MILIMÉTRICO CABEZA REDONDA**



Código 1	Código 2
531	M3
532	M4
5321	M5
5322	M6

Todas las imágenes son referenciales al producto original

BISAGRAS

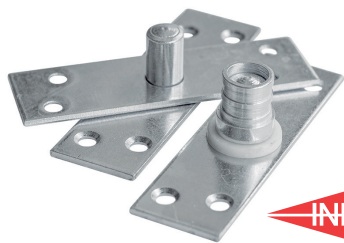

BISAGRA PIVOTE			
Código 1	Medidas	Color	
082	50MM	Zincado	
08211	25 MM	Zincado	
0821		Zincado	



BISAGRA COMUN			
Código 1	Medidas	Color	
084	2 1/2"	Hierro	
083	2"	Hierro	

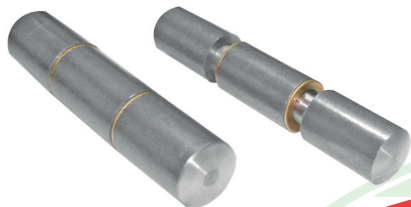

BISAGRA PISTÓN 3 CUERPO INDUMA			
Código 1	Medidas	Color	
0980	1/2"	Hierro	
0981	3/8"	Hierro	
0982	5/8"	Hierro	
0983	3/4"	Hierro	



BISAGRA PISTÓN			
Código 1	Medidas	Color	
095	3/4	Hierro	
096	5/8	Hierro	
097	1/2	Hierro	
098	3/8	Hierro	

Todas las imágenes son referenciales al producto original

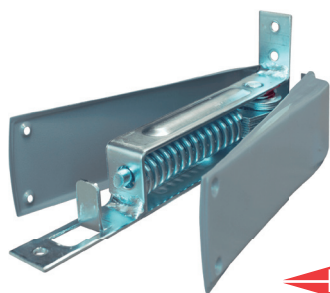









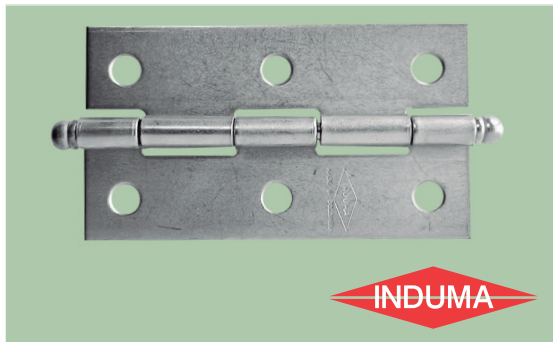

BISAGRA VAIVÉN PARA PISO		
Código 1	Color	
062	Dorado	
063	Café	
064	Zincado	
0641	SN	
0642	AB	



BISAGRA OMEGA			
Código 1	Medidas	Color	
704611	4"	AB	
704609	4"	MB	
704610	4"	SN	
704613	4"	Ace. inoxidable	
704612	4"	Blanco	

**BISAGRA DE MUEBLE**





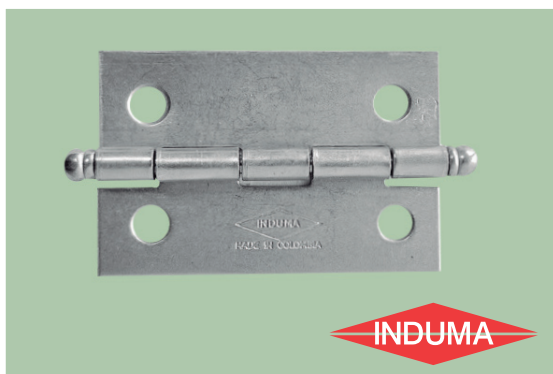

Código 1	Medidas	Color	
068	1 1/2"	Dorado	
077	1 1/2"	Pavonado	
0810	1 1/2"	SN	
072	2 1/2"	Dorado	
079	2 1/2"	Pavonado	
0812	2 1/2"	SN	
073	3"	Dorado	
081	3"	Pavonado	
0813	3"	SN	

**BISAGRA DE MUEBLE**



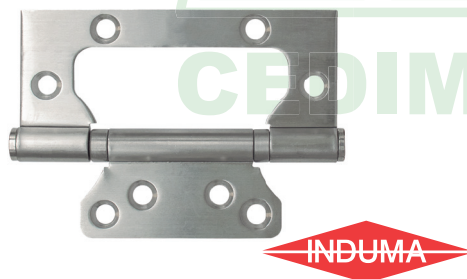

CAJA POR DOCENAS			
Código 1	Medidas	Color	
070	2"	Dorado	
078	2"	Pavonado	
0811	2"	SN	

CAJA POR DOCENAS			
Código 1	Medidas	Color	
066	1"	Dorado	
075	1"	Pavonado	
065	3/4"	Dorado	
074	3/4"	Pavonado	





BISAGRA OMEGA ACERO INOX. RULIMÁN			
Código 1	Medidas	Color	
094407	4"	Ace. inoxidable	



BISAGRA NUDO ACERO INOX RULIMÁN			
Código 1	Medidas	Color	
0947	3X3"	Ace. inoxidable	
09471	4X3"	Ace. inoxidable	



BISAGRA VAIVEN			
Código 1	Medidas	Color	
715910	3"	Negro	
71592	4"	Negro	
71593	5"	Negro	

Todas las imágenes son referenciales al producto original

CATÁLOGO DE PRODUCTOS HERRAJES

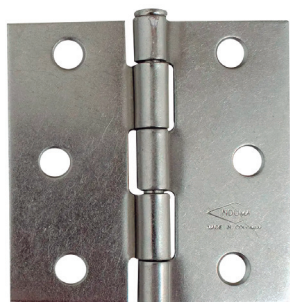

BISAGRA NUDO C.P. EMPAQUE TRÍO			
Código 1	Medidas	Color	
0945	3X3"	SN	
094501	3X3"	Dorado	
0946	3.5X3.5"	SN	
094602	3.5X3.5"	Dorado	
0946021	4X3"	SN	



BISAGRA OMEGA MUEBLE			
Código 1	Medidas	Color	
085	2"	Dorado	
086	2"	Pavonado	
0943	3X1"	Zincado	
0944	3X1"	Pavonado	

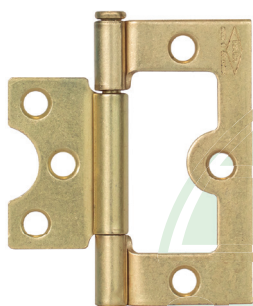

BISAGRA OMEGA IN			
Código 1	Medidas	Color	
094402	3 1/2"	Zincado	
094401	3"	Zincado	
09440	3"	Dorado	

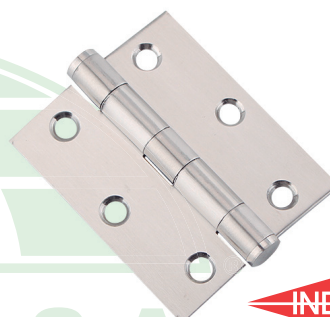

BISAGRA PARA PUERTA			
Código 1	Medidas	Color	
701	3X3"	Dorado	
702	3X3"	SN	
7020	3X3"	AB	

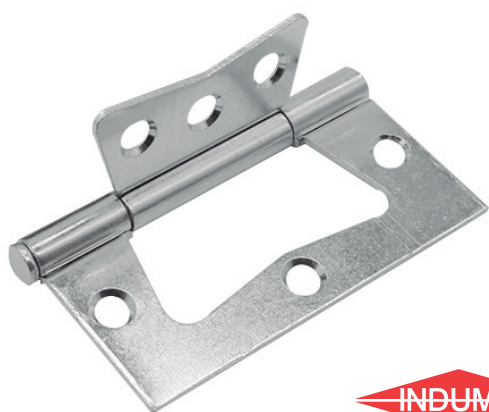

BISAGRA OMEGA			
Código 1	Medidas	Color	
0860	2"	SN	
087	3"	Dorado	
088	3"	Pavonado	
090	3"	Zincado	
091	3"	Blanco	
092	3"	Negro	
094	3"	Aliminiz ST	
0940	3"	SN	
0941	3"	Zincado	
09421	4"	SN	

Todas las imágenes son referenciales al producto original



BISAGRA OMEGA IN EMPAQUE TRÍO			
Código 1	Medidas	Color	
094403	3"	Zincado	
094405	3"	SN	
094404	3 1/2"	Zincado	
094406	3 1/2"	SN	



BISAGRA PRESIÓN			
Código 1	Medidas	Color	
100099	70X38,5 MM	AC	
100100	70X38,5 MM	BP	
100101	70X38,5 MM	Zincado	

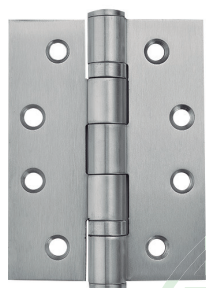

BISAGRA PARA PUERTA RULIMÁN			
Código 1	Medidas	Color	
7045	3X3"	Ace. inoxidable	
7043	3X3"	SN	



BISAGRA NUDO			
Código 1	Medidas	Color	
094603	3.5 X 3.5	Dorado	
094503	3 X 3"	Dorado	



BISAGRA REFORZADA HIERRO			
Código 1	Medidas	Color	
708	1"X1.00 MM	Black matte	
709	1 1/2"X1.2 MM	Black matte	
710	2"X1.2 MM	Black matte	
711	2 1/2"X1.4 MM	Black matte	
712	3"X1.6 MM	Black matte	
713	3 1/2"X1.6 MM	Black matte	
714	4"X1.8 MM	Black matte	
715	5"X2.00 MM	Black matte	

Todas las imágenes son referenciales al producto original

☎ 0997896093

✉ info@cedimportsa.com

✉ ventas@cedimportsa.com

📍 Parque Industrial Inmaconsa Calle A sn y Tecas



CATÁLOGO DE PRODUCTOS HERRAJES



SALFORD®

BISAGRA			
Código 1	Medidas	Color	
7150	1"	Hierro dorado	
7152	2"	Hierro dorado	
7153	2 1/2"	Hierro dorado	
7154	3"	Hierro dorado	

BISAGRA PARA PUERTA			
Código 1	Medidas	Color	
704601	3X3"	Black matte	
704602	3,5X3,5"	Black matte	
704603	3X3"	Dorado satín	
704604	3X3"	SN	



SALFORD®



SALFORD®

BISAGRA PARA PUERTA			
CAJA POR 100 PARES			
Código 1	Medidas	Color	
703	3,5X3,5"	Dorado	
7035	3,5X3,5"	AB	
704	3.5X3.5"	SN	

BISAGRA PARA PUERTA RULIMÁN			
CAJA POR 100 PARES			
Código 1	Medidas	Color	
7044	3,5X3,5"	SN	
7046	3,5X3,5"	SS	



SALFORD®



SALFORD®





BISAGRA EN T			
CAJA POR 100 UNIDADES			
Código 1	Medidas	Color	
7158	3"	Zincado	
7159	4"	Zincado	
71590	6"	Zincado	
71591	8"	Zincado	

BISAGRA			
Código 1	Medidas	Color	
7040	2.5X2.5	SN	
704608	3.5X3.5	AB	
704606	3.5X3.5	Dorado	
704607	3.5X3.5	SN	
704605	3X3	AB	

Todas las imágenes son referenciales al producto original





**SALFORD®**

BISAGRA RULIMANES			
Código 1	Medidas	Color	
70441	3X3"	Black matte	
7043	3X3"	SN	
70442	3X3.5"	Black matte	





**SALFORD®**

BISAGRA LARGA			
Código 1	Medidas	Color	
7155	3"	Zincado	
7156	4"	Zincado	
7157	5"	Zincado	



**SALFORD®**

BISAGRA SALFORD			
Código 1	Medidas	Color	
7042	2.5X2.5	AB	
7041	2.5X2.5	Dorado	



BISAGRA DE PRESIÓN TAIWAN			
Código 1	Color		
705	BP		
706	AB		
707	SN		
7075	AC		
7076	Blanco		

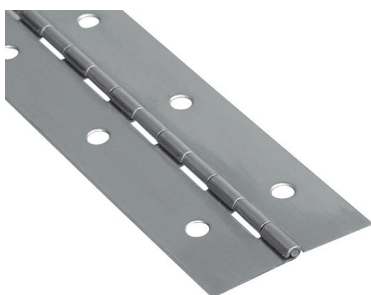

BISAGRA TIPO PIANO			
CAJA POR 400 UNIDADES			
Código 1	Medidas	Color	
9995912	27X0.8MMX91.5CM	Dorado	
9995914	32X0.8MMX91.5CM	Dorado	
9995915	32X0.8MMX91.5CM	SN	
99959151	25X0.50MMX180MM	Ace. inoxidable	
9995952	30X0.8MMX91.5CM	Ace. inoxidable	

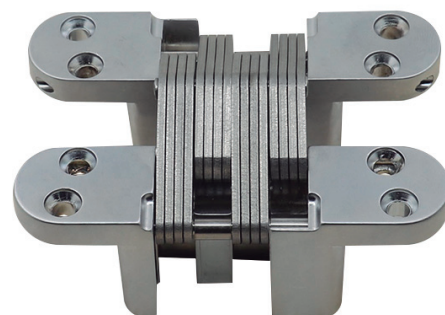

BISAGRA INVISIBLE			
CAJA POR 100 PARES			
Código 1	Medidas	Color	
621755	45 MM	SN	
621756	45 MM	AB	
621757	70 MM	SN	
621758	70 MM	AB	
621760	155 MM	MB	

Todas las imágenes son referenciales al producto original

CATÁLOGO DE PRODUCTOS HERRAJES

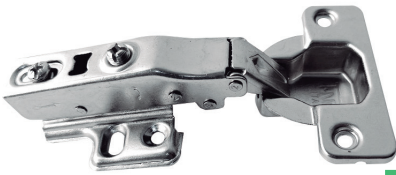

BISAGRA CIERRE LENTO RECTA TNN

Código 1	Medidas	Color	
5987	35 MM	SN	

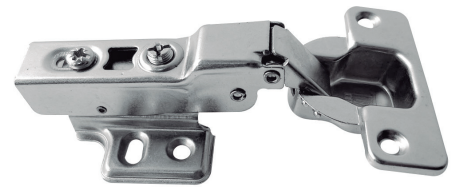

BISAGRA CIERRE LENTO SEMICODO TNN

Código 1	Medidas	Color	
5986	35 MM	SN	



BISAGRA SEMICODO TNN

Código 1	Medidas	Color	
59875	35 MM	Black matte	



BISAGRA RECTA TNN

Código 1	Medidas	Color	
59874	35 MM	Black matte	

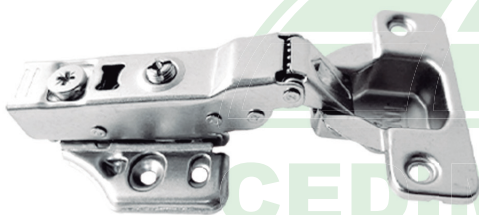

BISAGRA SEMICODO SOFT CLOSE - CLIP ON

Código 1	Código 2	Medidas	Color	
59872	SP1-08A	35 MM	SN	

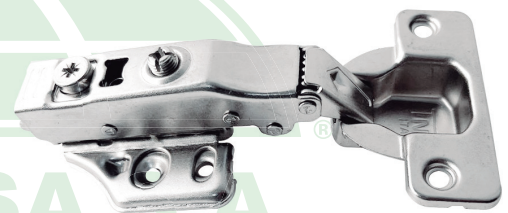

BISAGRA RECTA SOFT CLOSE CLIP ON

Código 1	Código 2	Medidas	Color	
59871	SP1-09A	35 MM	Zincado	
59870	SP3-07	35 MM	SN	



BISAGRA CODO

Código 1	Código 2	Medidas	Color	
5981	2T CN-07	35 MM	SN	
5984	4T CN-07	35 MM	SN	
59876	CN-07	35 MM	MB	



BISAGRA CODO

Código 1	Código 2	Medidas	Color	
59891	SD-07	26 MM	SN	

Todas las imágenes son referenciales al producto original

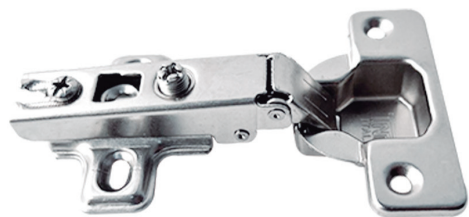

**BISAGRA RECTA PARA ANAQUEL**

Código 1	Medidas	Tornillos	Color
597	35 MM	2T	SN
5982	35 MM	4T	SN

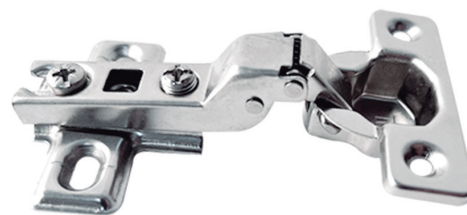

**BISAGRA SEMICODO PARA ANAQUEL**

Código 1	Medidas	Tornillos	Color
598	35 MM	2T	SN
5983	35 MM	4T	SN

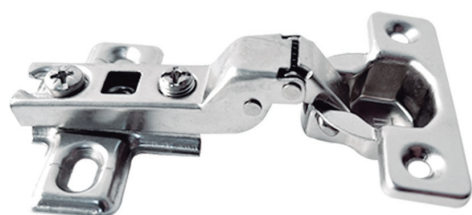

**BISAGRA SEMICODO PARA ANAQUEL**

Código 1	Medidas	Color
5989	26 MM	SN
5988	26 MM	SN

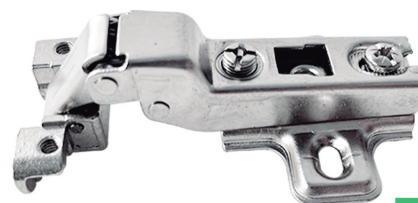

**BISAGRA SEMICODO TNN - PARA PERFIL ALUMINIO**

Código 1	Código 2	Color
6217541	A0801 C8	Aluminio

Todas las imágenes son referenciales al producto original

**CEDIMPORTSA S.A.**

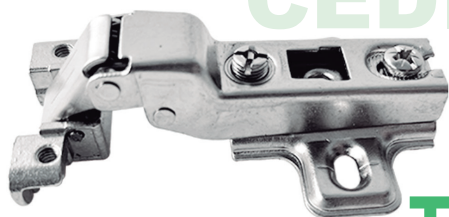

**BISAGRA RECTA TNN - PARA PUERTA PERFIL ALUMINIO**

Código 1	Medidas	Color
6217540	A0801 C0	Aluminio

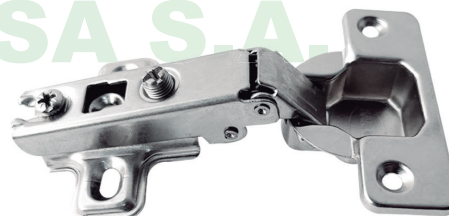

**BISAGRA RECTA SALFORD**

Código 1	Medidas	Color
599894	35 MM	Zincado



**SET BISAGRA Y TOPE DE PRESIÓN**

Código 1	Código 2	Medidas	Color
Recta 59892	CNY-09	35 MM	Cromado
Semicodo 59893	CNY-08	35 MM	Cromado
Codo 59894	CNY-07	35 MM	Cromado

CATÁLOGO DE PRODUCTOS HERRAJES

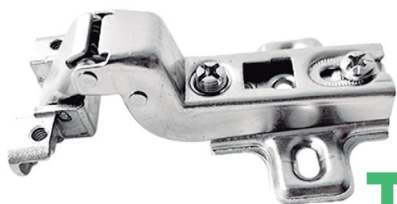

BISAGRA CODO TNN PERFIL - PARA PUERTA PERFIL ALUMINIO			
Código 1	Código 2	Color	
6217542	A0801 C15	Aluminio	

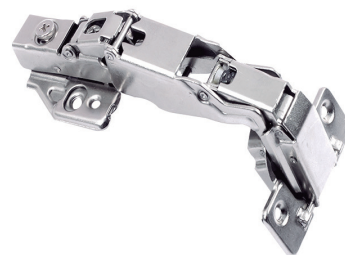

BISAGRA DE 175° RECTA				
Código 1	Código 2	Medidas	Color	
62191	CX-09	35 MM	SN	



BISAGRA DE 175° CODO				
Código 1	Código 2	Medidas	Color	
621921	CX-07	35 MM	SN	



BISAGRA DE 175° SEMICODO				
Código 1	Código 2	Medidas	Color	
62192	CX-08	35 MM	SN	

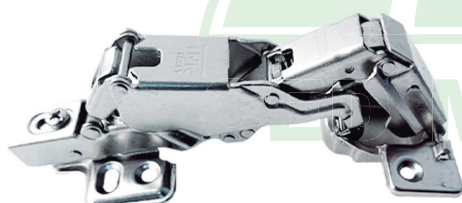

BISAGRA 165° RECTA SOFT CLOSE				
Código 1	Código 2	Medidas	Color	
62192101	SY-09	35 MM	SN	

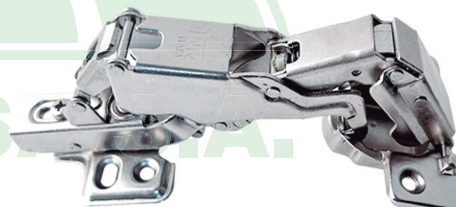

BISAGRA 165° SEMICODO SOFT CLOSE				
Código 1	Código 2	Medidas	Color	
62192102	SY-08	35 MM	SN	

Todas las imágenes son referenciales al producto original



BISAGRA DE 45° ANAQUEL				
Código 1	Código 2	Medidas	Color	
621922	SH-002	35 MM	SN	



BISAGRA DE 90° ANAQUEL				
Código 1	Código 2	Medidas	Color	
621923	SH-003	35 MM	SN	

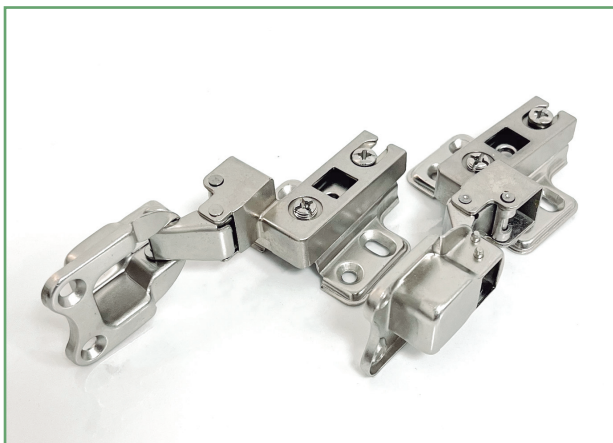

**BISAGRA ABATIBLE 110°**

Código 1	Código 2	Medidas	Color
621925	FH01 SM01	35MM	SN



**BISAGRA SOFT CLOSE AJUSTABLE 4D TNN**

Código 1	Código 2	Medidas	Color
621927	ADHX01	35MM	NEGRO

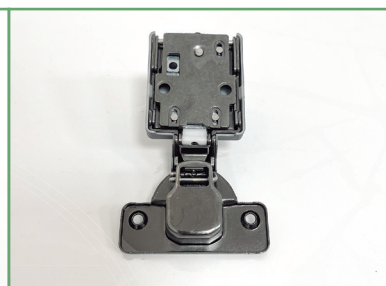

**BISAGRA 180° DOBLE COPA P. PLEGABLE TNN**

Código 1	Código 2	Color
621926	DCH01 SM02	SN



Todas las imágenes son referenciales al producto original

CATÁLOGO DE PRODUCTOS HERRAJES



BISAGRA DE 135° ANAQUEL

Código 1	Código 2	Medidas	Color	
621924	SH-001	35 MM	SN	

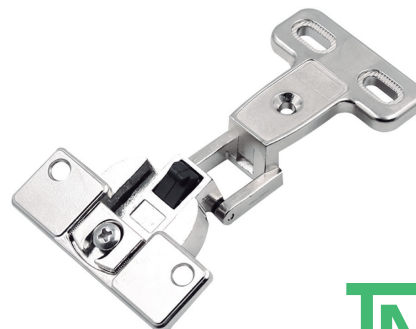

BISAGRA CODO 270° ANAQUEL

Código 1	Código 2	Medidas	Color	
97529001	C.2710	35 MM	Zincado	

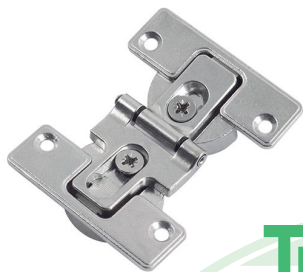

BISAGRA 245°

Código 1	Código 2	Medidas	Color	
9995917	R8103-12	65X60 MM	Zincado	



BISAGRA MAQ. PESADA

Código 1	Código 2	Medidas	Color	
9995916	1803-3NP	30X23X4 MM	Zincado	

CEDIMPORTSA S.A.

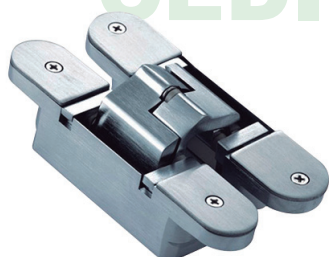

BISAGRA INVISIBLE AJUSTABLE

Código 1	Código 2	Medidas	Color	
621759	SH-012	115 MM	DN	

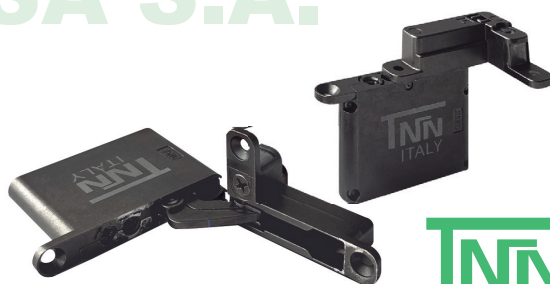

BISAGRA AEREA AJUSTABLE 3D

Código 1	Código 2	Color	
621999902	ADTH01	Negro	



BISAGRA DE MÁQUINA

Código 1	Código 2	Color	
621750	R 1803-5	BP	
621751	R 1803-5	SN	
621752	R 1803-5	AC	
621753	R 1803-5	Blanco	
621754	R 1803-5	AB	

Todas las imágenes son referenciales al producto original



BISAGRA PARA VIDRIO				
Código 1	Código 2	Medidas	Color	
62195	GH-01	5 MM	Zincado	



BISAGRA PARA VIDRIO				
Código 1	Código 2	Medidas	Color	
621950	GH-02	5 MM	Zincado	

## UNIONES, GRAPAS Y PASADORES

### ESQUINA UNIÓN PARA ZÓCALO PVC 90°



### CAJA POR 400 UNIDADES

Código 1	Medidas	Color	
97529010	100MM X 400MM	Aluminio	
97529011	120MM X 400MM	Aluminio	
97529012	150MM X 400MM	Aluminio	
975290090	100MM X 400MM	Negro	

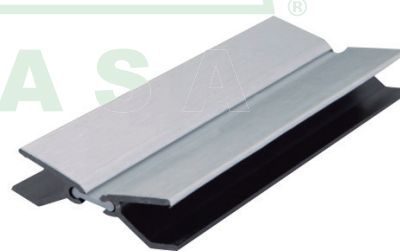

### UNION 180° PVC PARA ZOCALO

Código 1	Medida	Color	
975290120	100MM	Aluminio	
975290121	120MM	Aluminio	
975290122	150MM	Aluminio	

### UNIÓN MOVIBLE PARA ZÓCALO PVC

Código 1	Medida	Color	
975290123	100 MM	Aluminio	
975290124	120 MM	Aluminio	
975290125	150 MM	Aluminio	

### ZÓCALO PVC ANAQUEL COCINA

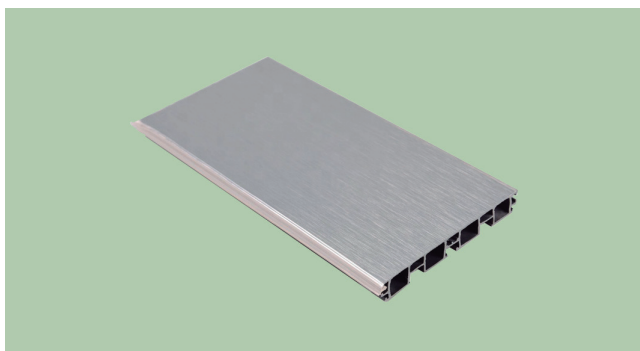

### EMPAQUE POR 10 UNIDADES

Código 1	Medidas	Color	
975290061	100MM X 4M	Aluminio	
97529006	100MM X 4M	Gris	
97529007	120MM X 4M	Aluminio	
97529008	150MM X 4M	Zincado	
9752900802	150MM X 4M	Negro	
9752900801	120MM X 4M	Negro	
97529009	100M X 4 M	Negro	

Todas las imágenes son referenciales al producto original

CATÁLOGO DE PRODUCTOS HERRAJES



GRAPA CAMA LUNA MIEL MUEBLE			
Código 1	Medidas	Color	
1034	69MM	Zincado	
1031	4 1/2"	Zincado	
103	4 1/2"	Dorado	
1033	180MM	Zincado	
1032	160MM	Zincado	

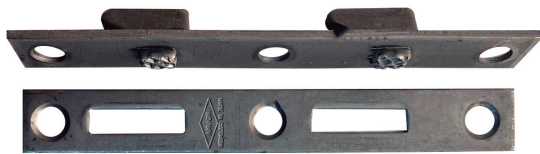

GRAPA PARA CAMA COMÚN			
Código 1	Medidas	Color	
109	5"	Hierro	

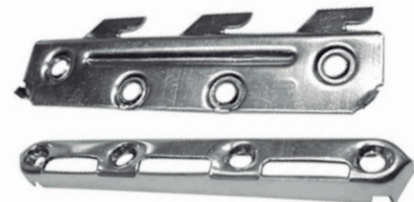

GRAPA PARA CAMA OJO DE PEZ			
Código 1	Medidas	Color	
104	5"	Zincado	

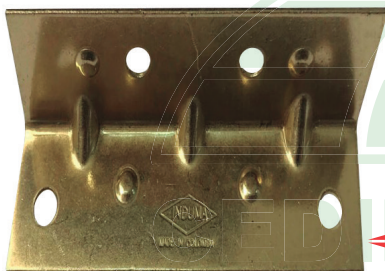

ÁNGULO PARA CAMA CAJA POR 96 SETS			
Código 1	Medidas	Color	
102	4.5"	Dorado	

PASADOR CUADRADO

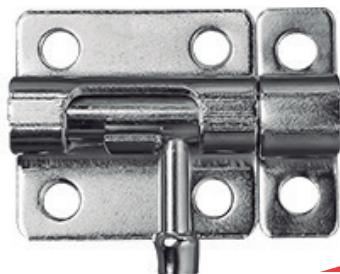

CAJA POR 200 UNIDADES		
Código 1	Medidas	
0613	3"	
0616	3"	
0619	3"	
06193	3"	

CAJA POR 300 UNIDADES		
Código 1	Medidas	
0611	2"	
0612	2 1/2"	
0614	2"	
0615	2 1/2"	
0617	2"	
0618	2 1/2"	
06130	1 1/2"	
06191	1 1/2"	
06192	2"	

TABLA DE COLORES	
ZINCADO	
LTV	
SN	
BLANCO	

Todas las imágenes son referenciales al producto original

☎ 0997896093

✉ info@cedimportsa.com

✉ ventas@cedimportsa.com

📍 Parque Industrial Inmaconsa Calle A sn y Tecas



**PASADOR ALEMÁN**

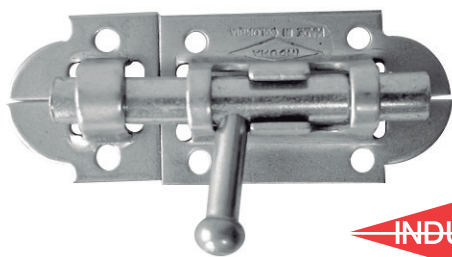

CAJA POR 96 DOCENAS			CAJA POR 22 DOCENAS		
Código 1	Medidas		Código 1	Medidas	
042	1 1/2"		044	2 1/2"	
04501	1 1/2"		04503	2 1/2"	
04505	1 1/2"		04507	2 1/2"	

CAJA POR 30 DOCENAS			CAJA POR 18 DOCENAS		
Código 1	Medidas		Código 1	Medidas	
043	2"		045	3"	
04502	2"		04504	3"	
04506	2"		04508	3"	

**PASADOR SUECO**

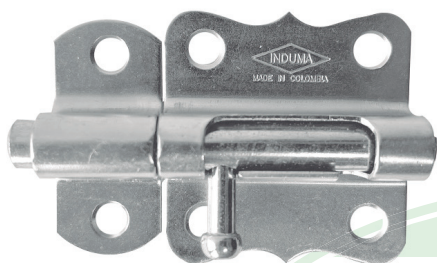

CAJA POR 30 DOCENAS			
Código 1	Medidas	Color	
060	2"	Dorado	
0600	2"	Zincado	

CAJA POR 18 DOCENAS			
Código 1	Medidas	Color	
061	2 1/2"	Dorado	
0610	2 1/2"	Zincado	

**BASES GIRATORIAS, BASE ESCRITORIO Y CAMA, PLATINA**



BASE GIRATORIA			
CAJA POR 12 UNIDADES			
Código 1	Medidas	Color	
6219940	3X3"	Negro	
621996	6X6"	Negro	
621994	8X8"	Negro	
621995	10X10"	Negro	

BASE GIRATORIA			
CAJA POR 12 UNIDADES			
Código 1	Medidas	Color	
9995919	200 MM	Gris	
9995920	250 MM	Gris	
9995921	300 MM	Gris	



BASE ESCRITORIO			
Código 1	Medidas	Color	
9999932	725X456	Negro	

Todas las imágenes son referenciales al producto original



# BASES DE MESAS



Todas las imágenes son referenciales al producto original



BASE METÁLICA MESA			
Código 1	Código 2	Medidas	Color
9995918	B0601-12	720 MM	Ace. Inoxidable

BASE METÁLICA MESA			
Código 1	Código 2	Medidas	Color
99959180	B0601-12	720 MM	Matte black



BASE METÁLICA MESA B.CRUZ			
Código 1	Código 2	Medidas	Color
99959181	07001	720 MM	Matte black



BASE METÁLICA MESA B.CRUZ			
Código 1	Código 2	Medidas	Color
99959182	07003	720 MM	Negro



BASE DE ACERO NEUMÁTICA SOFA CAMA		
Código 1	Código 2	Plazas
97529050	MC.1202	1 1/2
97529051	MC.1203	2

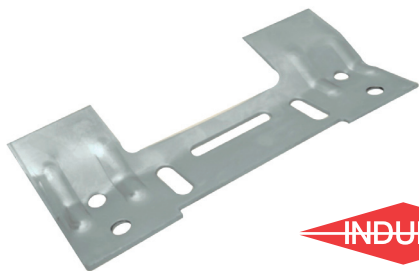

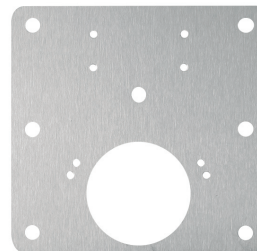

PLATINA SUJETADORA LAVAMANOS	
Código 1	
162	

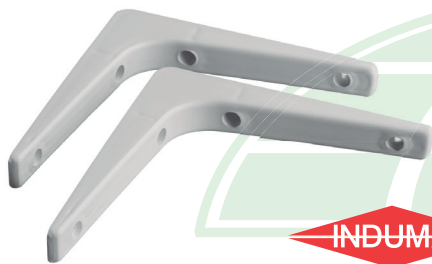

PLACA ACERO INOX.REPARACION BISAGRA		
Código 1	Código 2	Medidas
621999901	AL-80-H	35MM

Todas las imágenes son referenciales al producto original



PIE DE AMIGO PLÁSTICO			
CAJA DE 50 PARES			
Código 1	Medidas	Color	
1680	7X7"	Blanco	
1681	7X7"	Negro	
1682	7X7"	Gris	

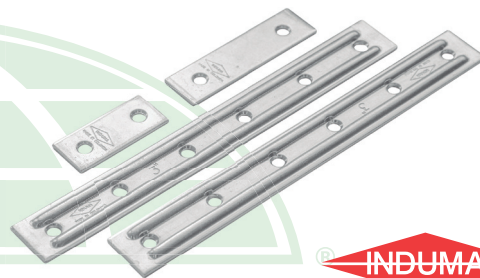

PLATINA DE REFUERZO			
Código 1	Medidas	Color	
59199	1 1/2"	Zincado	
5919901	2 1/2"	Zincado	
5919902	3"	Zincado	
5919903	4"	Zincado	
5919904	5"	Zincado	
5919905	6"	Zincado	
5919906	8"	Zincado	

**KIT, PORTACANDADO, ESCUADRA Y PICAPORTE**

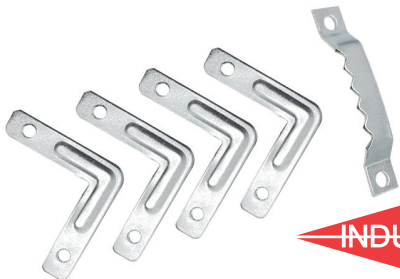

KIT DE MARQUETERÍA SOP	
Código 1	Medidas
1610	1 1/2"
1611	2 1/2"



PICAPORTE UÑA ACERO INOXIDABLE			
Código 1	Medidas	Color	
975290330	12"	SS	
97529033	6"	SS	

CATÁLOGO DE PRODUCTOS HERRAJES

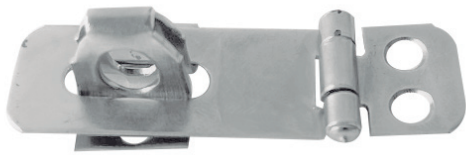

PORTACANDADO			
CAJA POR 16 DOCENAS			
Código 1	Medidas	Cantidad por caja	Color
046	1 1/2"	96	Dorado
053	1 1/2"	96	Zincado
047	2"	60	Dorado
054	2"	60	Zincado
049	3"	22	Dorado
048	2 1/2"	44	Dorado
055	2 1/2"	44	Zincado



PORTACANDADO			
CAJA POR 16 DOCENAS			
Código 1	Medidas	Cantidad por caja	Color
050	3 1/2"	22	Dorado
056	3"	22	Zincado
051	4"	18	Dorado
052	4 1/2"	18	Dorado
057	3 1/2"	18	Pavonado
058	4"	18	Zincado
059	4 1/2"	18	Zincado



ESCUADRA DE REFUERZO 90* METAL		
Código 1	Medidas	Color
999592101	24X24X31.6MM	Zincado
999592103	26X26X40MMX0,9MM	Zincado
999592102	35X35X50X1,8MM	Zincado

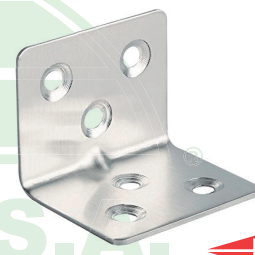

ESCUADRA DE REFUERZO 9°G METAL		
CATÓN POR 200 UNIDADES		
Código 1	Medidas	Color
16734	38X38X38 MM	Zincado



ESCUADRA DE REFUERZO INDUMA		
CAJA POR 100 UNIDADES		
Código 1	Medidas	Color
1671	1 1/4"	Zincado
1672	1/2"	Zincado
1673	2"	Zincado
16730	3"	Zincado
16731	4"	Zincado
16732	3/4"	Zincado
16733	1"	Zincado

Todas las imágenes son referenciales al producto original

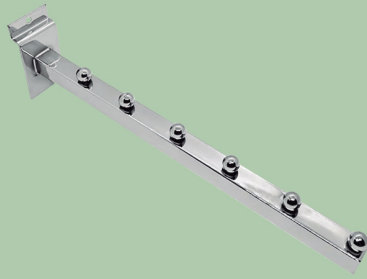

SOPORTE DE EXHIBICIÓN DE BOLAS

CAJA POR 24 UNIDADES

Código 1	Medidas	Color
929	3 BALLS	SN
930	4 BALLS	SN
931	5 BALLS	SN
932	6 BALLS	SN
933	7 BALLS	SN
934	9 BALLS	SN
935	11 BALLS	SN



SOPORTE GRADUABLE

Código 1	Medidas	Color
93901	17 CM	Blanco
9391	22 CM	Blanco
9392	27 CM	Blanco
9393	32 CM	Blanco
9394	37 CM	Blanco
9399001	17 CM	Blanco
9399002	22 CM	Blanco
9399003	27 CM	Blanco
9399004	32 CM	Blanco
9399005	37 CM	Blanco

Todas las imágenes son referenciales al producto original



SOPORTE GRADUADO SIMPLE

Código 1	Medidas	Código 2	Color
9399009	20 CM	SS50	Blanco
9399010	25 CM	SS50	Blanco
9399011	30 CM	SS50	Blanco
9399012	35 CM	SS50	Blanco



PILAR RANURADO SIMPLE

Código 1	Medidas	Código 2	Color
9399013	50 CM	SS50	Blanco
9399014	100 CM	SS50	Blanco
9399015	150 CM	SS50	Blanco

PILAR RANURADO SIMPLE Y DOBLE

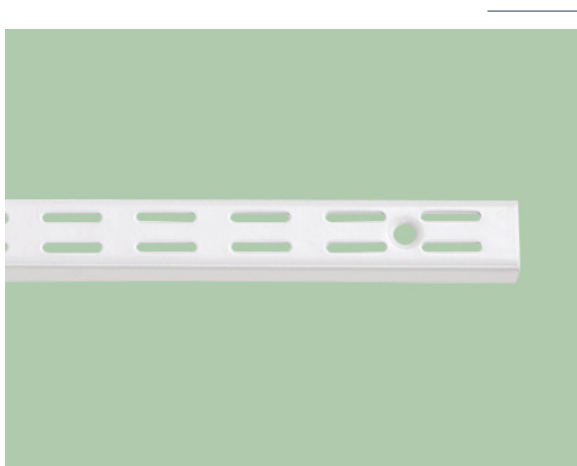

CAJA POR 100 UNIDADES

Código 1	Medidas	Color
9395	32 CM	Blanco
9396	66 CM	Blanco
9397	95 CM	Blanco
9398	140 CM	Blanco
9399	160 CM	Blanco
9399006	50 CM	Blanco
9399007	100 CM	Blanco
9399008	150 CM	Blanco
9399013	50 CM	Blanco
9399014	100 CM	Blanco
9399015	150 CM	Blanco

CATÁLOGO DE PRODUCTOS HERRAJES

GANCHO DE EXHIBICIÓN



Código 1	Medidas	Color
9351	2" X4 MM	Niquelado
9350	2" X6 MM	Niquelado
9352	4" X4 MM	Niquelado
92520	4" X4 MM	Negro
936	4" X6 MM	Niquelado
9253	4" X6 MM	Negro
937	6" X6 MM	Niquelado
9254	6" X6 MM	Negro
938	8" X6 MM	Niquelado
9255	8" X6 MM	Negro
939	10" X6 MM	Niquelado
9256	10" X6 MM	Negro
9390	12" X6 MM	Niquelado

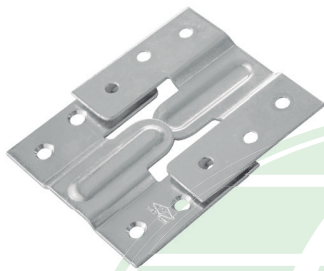

SOPORTE MULTIUSOS METÁLICO		
Código 1	Medidas	Color
16751	3 1/4" CAL 12	Zincado
1675	CAL 12	Zincado

SOPORTE REPISA EXHIBICIÓN		
Código 1	Medidas	Color
926	8"	SN
927	10"	SN
928	12"	SN

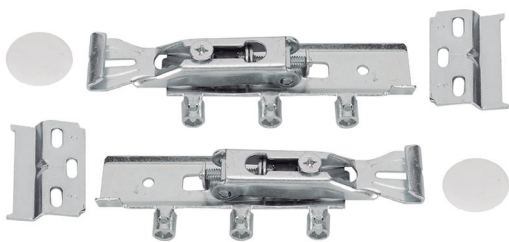

SOPORTE ANAQUEL PARED		
Código 1	Código 2	Color
9999938	CH1101	SN

SOPORTE TUBO REDONDO		
Código 1	Medidas	Color
621931	1"	SN

Todas las imágenes son referenciales al producto original

☎ 0997896093



✉ info@cedimportsa.com

✉ ventas@cedimportsa.com

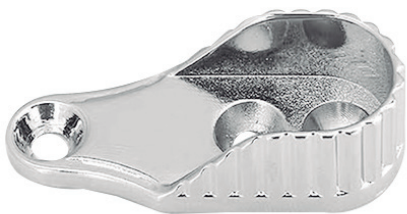

📍 Parque Industrial Inmaconsa Calle A sn y Tecas







SOPORTE OVALADO ECONÓMICO			
Código 1	Medidas	Color	
621934	15.5X32 MM	SN	





SOPORTE TUBO REDONDO			
Código 1	Código 2	Color	
413	ZD-3043	CP	



SOPORTE TUBO REDONDO			
Código 1	Medidas	Color	
4131	1/2"	SN	
41321	1"	SN	





SOPORTE TUBO OVALADO			
Código 1	Medidas	Color	
621932	15.5X32 MM	SN	



SOPORTE TUBO OVAL PLÁSTICO			
Código 1	Medidas	Color	
621933	17X40 MM	Blanco	



SOPORTE CENTRAL TUBO OVALADO			
Código 1	Medidas	Color	
62193	16.5X32 MM	Cromado	





TUBO CLOSET ABATIBLE		
Código 1	Código 2	Medidas
621900	ER004-1	H895 X W450-600MM
621901	ER004-2	H895 X W600-830MM
621902	ER004-3	H895 X W850-1500MM





Todas las imágenes son referenciales al producto original

CATÁLOGO DE PRODUCTOS HERRAJES



TUBO REDONDO METÁLICO PARA CLOSET			
Código 1	Medidas	Color	
6219	1"X1.1X3M	Cromado	
62190	1"X0.9X3M	Cromado	





TUBO REDONDO CLOSET			
Código 1	Medidas	Color	
62184	1"X0.9MMX300MM	Cromado	
62190	1"X0.9MMX200MM	Cromado	
6219	1"X1.1X300MM	Cromado	
62183	3/4X0.9X300MM	Cromado	















TUBO OVALADO METÁLICO PARA CLOSET			
Código 1	Medidas	Color	
62182	15X30X1 MM X 3M	Cromado	
62181	15X30X1 MM X 3M	Blanco	



TUBO OVALADO ALUMINIO PARA CLOSET				
Código 1	Código 2	Medidas	Color	
62180	GYC-2011	1.5X30MMX3M	Silver	
975290491	GYC-2011	1.5X30MMX3M	Negro	



TUBO CORTINA ALUMINIO			
Código 1	Medidas	Color	
621694420	1/2"X6.15M 1.28MM	Dorado	
621694421	3/4"X6.15M	Dorado	
621694422	1"X6.15M	Dorado	
621694423	1/2" X 6.15M 1.28MM	Silver	
621694425	3/4" X 6.15M	Silver	
621694424	1" X 6.15M	Silver	
621694426	1/2" X 6.40M 1.28MM	Brown	
621694427	3/4" X 6.40M	Brown	
621694428	1" X 6.40M	Brown	
621694429	1/2" X 6.40M 1.28MM	Dorado	
6216944291	3/4" X 6.40M	Dorado	
6216944292	1" X 6.40M	Dorado	
6216944293	1/2" X 6.00M 1.28MM	Dorado	
6216944294	3/4" X 6.00M	Dorado	
6216944295	1" X 6.00M	Dorado	

Todas las imágenes son referenciales al producto original









SOPORTE MURO CORTINA			
Código 1	Medidas	Color	
99971	1/2"	Dorado	
99972	3/4	Dorado	
99973	1	Dorado	
99979902	1/2	Plata	
99979903	3/4	Plata	
99979904	1	Plata	
999731	1/2	Café	
999732	3/4	Café	
999733	1	Café	

SOPORTE MURO CORTINA DOBLE			
Código 1	Medidas	Color	
99974	1/2	Dorado	
99975	3/4	Dorado	
99976	1	Dorado	
99979905	1/2	Plata	
99979906	3/4	Plata	
99979907	1	Plata	
999799141	1/2	Café	
999799142	3/4	Café	
999799143	1	Café	

Todas las imágenes son referenciales al producto original



TERMINAL TUBO CORTINA			
Código 1	Medidas	Color	
99977	1/2	Dorado	
99978	3/4	Dorado	
99979	1	Dorado	
99979912	1/2	Plata	
99979913	3/4	Plata	
99979914	1	Plata	



SOPORTE PLAFON ABIERTO			
Código 1	Medidas	Color	
99968	1/2	Dorado	
99969	3/4	Dorado	
99970	1	Dorado	
999798	1/2	Plata	
999799	3/4	Plata	
99979901	1	Plata	
999701	1/2	Café	
999702	3/4	Café	
999703	1	Café	

SOPORTE PLAFON CERRADO			
Código 1	Medidas	Color	
99965	1/2"	Dorado	
99966	3/4	Dorado	
99967	1	Dorado	
999795	1/2	Plata	
999796	3/4	Plata	
999797	1	Plata	

CATÁLOGO DE PRODUCTOS HERRAJES



ARGOLLA RANURADA		
Código 1	Medidas	Color
999790	1/2"	Dorado
999791	3/4	Dorado
999792	1	Dorado
99979915	1/2	Plata
99979916	3/4	Plata
99979917	1	Plata



BASTON ABIERTO PARA CORTINERO		
Código 1	Medidas	Color
999793	1/2"	Dorado/Café



BASTON CERRADO PARA CORTINERO		
Código 1	Medidas	Color
999794	3/4	Dorado/Café



TERMINAL AMERICANA		
Código 1	Medidas	Color
999760	3/4	Dorado
999761	1	Dorado
99979908	3/4	Plata
99979909	1	Plata



TERMINAL CUPULA		
Código 1	Medidas	Color
999762	3/4	Dorado
999763	1	Dorado
99979910	3/4	Plata
99979911	1	Plata



SOPORTE OCULTO		
Código 1	Código 2	Color
6219992	SB119	SN



SOPORTE PLASTICO TRANSPARENTE	
Código 1	Código 2
61199753	SC.6180

Todas las imágenes son referenciales al producto original

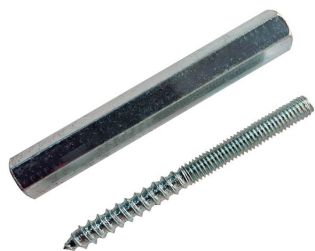

SOPORTE REPISA FLOTANTE	
Código 1	Código 2
61199752	SB.2660



SOPORTE CPU COMPUTADOR			
Código 1	Código 2	Color	
6219962	K528	Negro	



SOPORTE DE RÓTULO			
Código 1	Medidas	Color	
6217543	12X25 MM	Ace. inoxidable	
6217544	12X30 MM	Ace. inoxidable	
6217545	16X30 MM	Ace. inoxidable	
6217546	16X40 MM	Ace. inoxidable	
6217547	19X40 MM	Ace. inoxidable	
6217548	19X50 MM	Ace. inoxidable	
6217549	25X50 MM	Ace. inoxidable	
6217550	25X50 MM	Ace. inoxidable	
6217551	25X60 MM	Ace. inoxidable	

Todas las imágenes son referenciales al producto original



SOPORTE CON RESORTE			
Código 1	Medidas	Color	
621973	75-90°	Zincado	

SOPORTE A GAS				
Código 1	Código 2	Medidas	Color	
Soft close 621968	SFD007-5	100N	Zincado	
62197	SFD007	100N	Zincado	



SOPORTE INVERSO 90°				
Código 1	Código 2	Medidas	Color	
Redondo 621971	SFD002-3	275 MM	Zincado	
Plano 621972	SFD002-2	275 MM	Zincado	



SOPORTE 360° AÉREO			
CAJA POR 10 SETS			
Código 1	Código 2	Color	
9995911	SF0018 (ST.3203)	Zincado	

CATÁLOGO DE PRODUCTOS HERRAJES

SOPORTE REPISA CON BORDE BLANCO



Código 1	Código 2
6142	004-3

SOPORTE REPISA SIN BORDE BLANCO



Código 1	Código 2
615	004-2

SOPORTE REPISA CON BORDE CAFÉ



Código 1	Código 2
61501	004-3

SOPORTE REPISA SIN BORDE CAFÉ



Código 1	Código 2
6150	004-2

SOPORTE REPISA CON BORDE NEGRO



Código 1	Código 2
6141	004-3

SOPORTE REPISA SIN BORDE NEGRO



Código 1	Código 2
61410	004-2

SOPORTE REPISA CON BORDE TRANSPARENTE



Código 1	Código 2
6140	004-3

SOPORTE REPISA SIN BORDE TRANSPARENTE



Código 1	Código 2
614	004-2

Todas las imágenes son referenciales al producto original



AVENTO PLEGABLE				
Código 1	Código 2	Peso	Color	
62199892	SFD030	110G	Gris	



AVENTO 107'				
Código 1	Código 2	Peso	Color	
62199891	SFD031	6 KG	Gris	

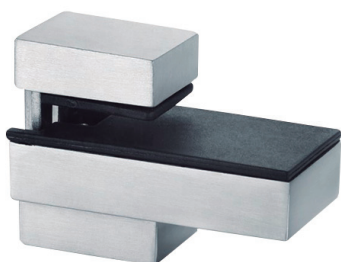

SOPORTE REPISA VIDRIO AJUSTABLE			
Código 1	Medidas	Color	
97529043	57X28 MM	Zincado	
97529042	51X25 MM	Zincado	



SOPORTE REPISA VIDRIO AJUSTABLE			
Código 1	Medidas	Color	
97529044	84X28 MM	Zincado	
97529045	100X28 MM	Zincado	



SOPORTE METAL VIDRIO				
Código 1	Código 2	Medidas	Color	
850999137	ES3106S	S	SN	
850999138	ES31016L	L	SN	



SOPORTE REPISA VIDRIO			
Código 1	Medidas	Color	
975290450	10 MM	SN	
975290451	12 MM	SN	



SOPORTE REPISA VIDRIO			
Código 1	Medidas	Color	
615020	30X54 MM	SN	
61502	75X31 MM	SN	



SOPORTE REPISA VIDRIO			
Código 1	Código 2	Color	
61503	GC001-2	SN	
61504	GC001-1	SN	

Todas las imágenes son referenciales al producto original

CATÁLOGO DE PRODUCTOS HERRAJES



BISAGRA VIDRIO CABINA BAÑO BAÑO 135°

Código 1	Código 2	Color
99979940	JM203	NEGRO
99979939	JM203	SATINADO

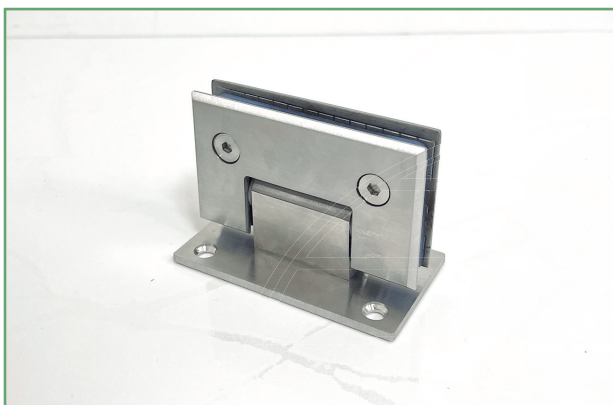

BISAGRA VIDRIO CABINA BAÑO PARED 180°

Código 1	Código 2	Color
99979934	JM201	NEGRO
99979933	JM201	SATINADO

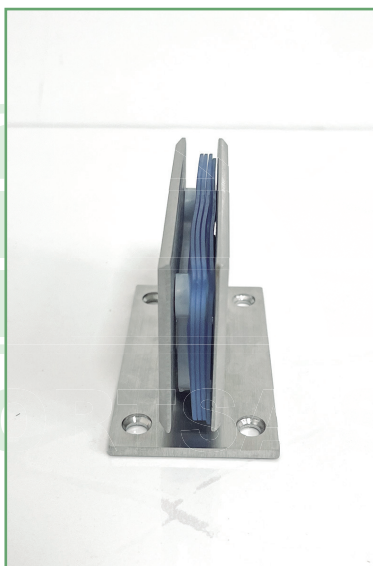

BISAGRA VIDRIO CABINA BAÑO PARED 90°

Código 1	Código 2	Color
99979936	JM200B	NEGRO
99979935	JM200B	SATINADO



Todas las imágenes son referenciales al producto original



**CONECTOR FIJO GABINETE BAÑO 90°**

Código 1	Código 2	Color
99979940	JM203	NEGRO
99979939	JM203	SATINADO

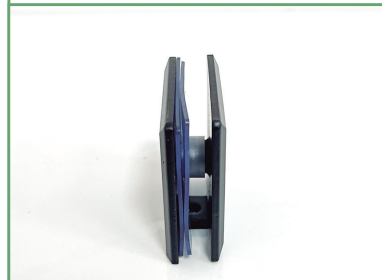
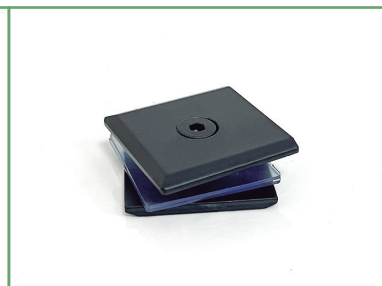

**CONECTOR VIDRIO TEMPLADO 8-12MM REGULABLE**

Código 1	Código 2	Color
99979932	JM-EC03	NEGRO
99979931	JM-EC03	SATINADO



El Conector para Vidrio Templado Regulable 8-12 mm es un accesorio de alta calidad diseñado para brindar una fijación segura, resistente y estética en instalaciones de vidrio templado. Fabricado en acero inoxidable con acabado satinado, ofrece excelente resistencia a la corrosión, la humedad y el desgaste, siendo ideal para aplicaciones tanto en interiores como en exteriores.

**APLICACIONES**

Divisiones de vidrio.



Barandas y pasamanos.



Cerramientos comerciales.



Mamparas de baño.

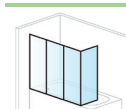

Todas las imágenes son referenciales al producto original

CATÁLOGO DE PRODUCTOS HERRAJES



SOPORTE REPISA VIDRIO			
CAJA POR 500 UNIDADES			
Código 1	Código 2	Color	
61505	GC006-1	SN	



CONECTOR DE MUEBLE			
Código 1	Código 2	Color	
612000	FC002	Blanco	
6120001	FC002	Café	

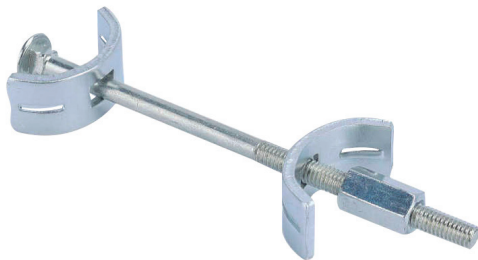

CONECTOR DE ESCRITORIO			
Código 1	Medidas	Color	
612007	M6X100	Zincado	



CONECTOR MINIFIX EXCENTRICO			
Código 1	Medidas	Color	
612008	15X12 MM	Ace. inoxidable	

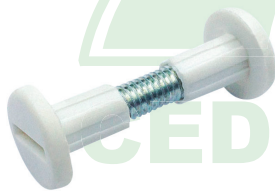

CONECTOR PLÁSTICO TORNILLO			
Código 1	Medidas	Color	
612001	M6X30 MM	Blanco	
612003	M6X40 MM	Blanco	
612004	M6X30 MM	Café	
612006	M6X40 MM	Café	

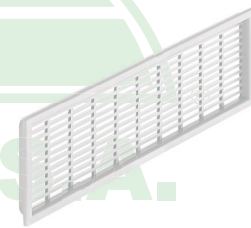

BANDEJA PLÁSTICA VENTILACIÓN			
CARTÓN POR 400 UNIDADES			
Código 1	Medidas	Color	
6219991	227X67 MM	Zincado	

RUEDA, GANCHOS Y PILARES



RUEDA PUERTA CORREDIZA TNN			
CAJA POR 50 SETS			
Código 1	Código 2	Peso max. por puerta	Color
6219990	RSD10	80 KG	Cromado



RUEDA AL PISO 2 PATAS SIMPLES TNN			
CAJA POR 50 SETS			
Código 1	Código 2	Peso max. por puerta	Color
62199901	RSD20	30 KG	Cromado

Todas las imágenes son referenciales al producto original



**RUEDA PUERTA CORREDIZA TNN**

Código 1	Código 2	Peso	Color
62199903	RSD30	45 KG	Cromado

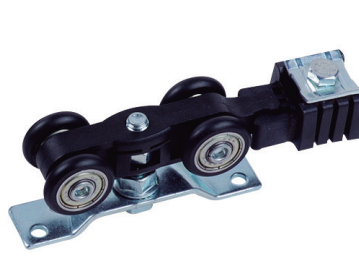

**RUEDA 1 PUERTA TNN**

Código 1	Código 2	Color
62199905	RSD 609	Negro

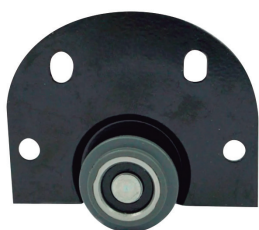

**RUEDA PUERTA CORREDIZA TNN**

Código 1	Código 2	Peso max. por puerta	Color
62199904	RSD50	50 KG	Black matte



**GANCHO COLGAR ROPA**

Código 1	Medidas	Color
820	1,5	Gris



**GANCHO COLGAR ROPA ACERO INOXIDABLE**

**CAJA POR 50 UNIDADES**

Código 1	Medidas	Color
97529032	4 GANCHOS	Ace. inoxidable

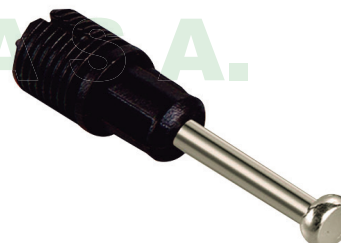

**TORNILLO MINI FIX**

**CAJA POR 500 UNIDADES**

Código 1	Código 2	Medidas	Color
612009	EF1514-2	M8X 11 MM	Acero inoxidable



**PIN DE MADERA**

**CAJA POR 10000 UNIDADES**

Código 1	Medidas	Color
613	8X30 MM	Madera
6130	8X40 MM	Madera
6131	10X40 MM	Madera
6132	12X40 MM	Madera

Todas las imágenes son referenciales al producto original

## TOPES

### TOPE DE PUERTA FLEXIBLE



Código 1	Color	
166	Dorado	
167	Pavonado	
1670	Zincado	
16701	SN	

### TOPE MAGNÉTICO



Código 1	Código 2	Medidas	
621963	MC-03A	45X16MM	
621964	MC-03A	45X16MM	

### TOPE DE IMPACTO ADHESIVO

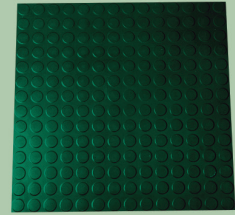

Código 1	Código 2
62196	BF-01

### SET TOPE Y BISAGRA VIDRIO



Código 1	Código 2	Medidas	
62194	CC.4311	8X30MM	
621940	CC.4311	8X40MM	

### TOPE PUSH

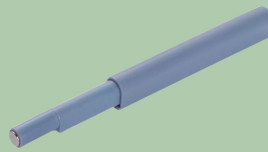

Código 1	Código 2	
6219512	SRC009	
6219511	SRC009	

### TOPE PUSH



Código 1	Código 2	Medidas	
6219521	SRC101	74X18MM	
621952	SRC1010	74X18MM	

### TOPE CIERRE SUAVE

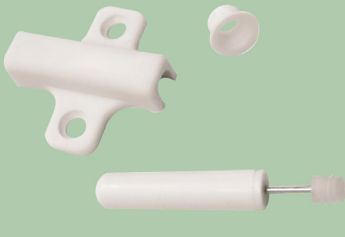

Código 1	Código 2	Medidas	
621960	SFD009-2	80X15MM	

### TOPE PUSH



Código 1	Código 2	Medidas	
6219531	SRC011	49X18MM	
621953	SRC011	49X18MM	

### TOPE PUSH

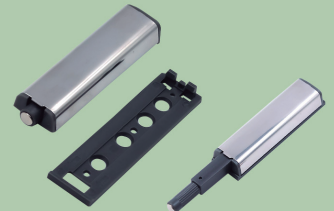

Código 1	Código 2	Medidas	
621954	SRC013	75X32MM	

### TOPE PUSH



Código 1	Código 2	
6119975	BP6060	
61199751	BP6020	

### TOPE PUERTA PISO



Código 1	Código 2	Medidas	
903	DO2020	20X40MM	
904	DO2020	20X40MM	
905	DO2020	20X40MM	
9051	DO2020	20X40MM	

### TOPE ENGRAJE



Código 1	Código 2	Medidas	
621961	DRC618	15X32MM	
621962	DRC618	15X32MM	

Todas las imágenes son referenciales al producto original

**TOPE DE PUERTA FLEXIBLE  
ACERO INOXIDABLE**



Código 1	Código 2	Medidas
97529017	DF.3268	38X75MM
97529018	DF.3269	50X95MM
97529019	DF.3270	50X88MM
97529020	DF.3271	25X100MM
97529021	DF.3273	46X98MM

**SISTEMA PUERTA/NIVELADOR/RESBALÓN/ACCESORIOS**



**SET SISTEMA PUERTA CORREDIZA MADER**

Código 1	Medidas	Color
99979919	200 MM	Negro

**SET SISTEMA PUERTA CORREDIZA MADERA ACE.  
INOXIDABLE**

Código 1	Medidas	Color
99979918	200 MM	SS

Todas las imágenes son referenciales al producto original



**SISTEMA PUERTA PLEGABLE**

Código 1	Código 2	Peso max. por puerta	Color
97529003	FW 7120	10 KG	Gris
97529002	FW 7220	25 KG	Gris

**NIVELADOR**

**CARTÓN POR 1000 UNIDADES**

Código 1	Código 2
611997	KFT005-1



**RESBALÓN**

Código 1	Medidas	Color
611998	22 MM	Café
611999	22 MM	Blanco

CATÁLOGO DE PRODUCTOS HERRAJES



RESBALÓN C/FIELTRO			
Código 1	Medidas	Color	
97529013	20 MM	Blanco	
97529014	22 MM	Blanco	
97529015	20 MM	Café	
97529016	22 MM	Café	



RESBALÓN C/CAUCHO			
Código 1	Medidas	Color	
6119971	20 MM	Blanco	
6119972	20 MM	Café	
6119973	22 MM	Blanco	
6119974	22 MM	Café	



PIVOT PUERTA ALUMINIO			
Código 1	Código 2	Peso	Color
97523	OP280BZ	70 KG	Café
97524	OP0280AC	70 KG	Aluminio



RESBALÓN METALICO		
Código 1	Código 2	Medidas
975290161	GL.1680	19MM
975290162	GL.1680	22 MM



PIVOT OCULTO PARA PUERTA		
Código 1	Código 2	Medidas
99979921	JM-BA	130X24 Y 104X85 MM

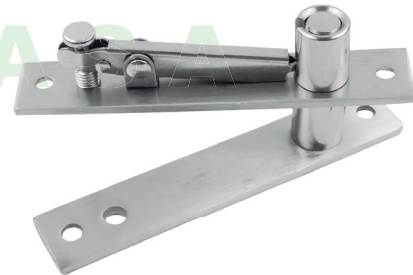

PIVOT OCULTO PARA PUERTA		
Código 1	Código 2	Medidas
99979920	NCY-30	30X24 Y 104X85 MM



ACCESORIO			
Código 1	Código 2	Color	
409	ZD-3024	Cromado	



ACCESORIO			
Código 1	Código 2	Color	
408	ZD-3022	Cromado	

Todas las imágenes son referenciales al producto original



ACCESORIO			
CAJA POR 300 UNIDADES			
Código 1	Código 2	Color	
411	ZD-3028	Cromado	



ACCESORIO			
CAJA POR 300 UNIDADES			
Código 1	Código 2	Color	
410	ZD-3026	Cromado	



ACCESORIO			
CAJA POR 300 UNIDADES			
Código 1	Código 2	Color	
4121	ZD-3005	Dorado	



ACCESORIO			
CAJA POR 300 UNIDADES			
Código 1	Código 2	Color	
412	ZD-3030	Cromado	

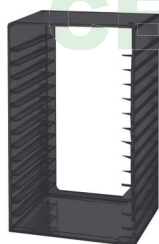

PORTA CD PLÁSTIO			
Código 1	Medidas	Color	
999999	15 ESPACIOS	Negro	
999998	20 ESPACIOS	Negro	



ACCESORIO NIVELADOR			
CAJA POR 1000 UNIDADES			
Código 1	Código 2	Color	
6119970	FCN001-3	Zincado	



LUZ LED UNIVERSAL BISAGRA			
Código 1	Medidas	Color	
621999900	35 MM	Gris	



SEGURO DE ENGRAJE				
Código 1	Código 2	Medidas	Color	
621951	SRC004	43X8.5 MM	Dorado	

Todas las imágenes son referenciales al producto original

CATÁLOGO DE PRODUCTOS HERRAJES

ACCESORIOS PARA VENTANAS Y PUERTA DE VIDRIO



Todas las imágenes son referenciales al producto original



MANIJA SEGURO DE PUERTA DH-6028

Código 1	Color
66413	Negro
66412	Blanco



TIRADERA PUERTA CORREDIZA DH-6307

Código 1	Medidas	Color
66402	7"	Negro
66401	7"	Blanco



PIVOT PUERTA ALUMINIO HL6251B

Código 1	Color
66404	Negro
66403	Blanco



CERRADURA PUERTA CORREDIZA TB-6073

Código 1	Color
66415	Negro
66414	Blanco



SEGURO BOTON DE VENTANA TB6068A		
Código 1	Color	
66417	Negro	
66416	Blanco	



CIERRE MEDIA LUNA DE VENTANA TB6109		
Código 1	Color	
66419	Negro	
66418	Blanco	



MANIJA SEGURO DE VENTANA WH6001			
Código 1	Lado	Color	
66408	Izquierdo	Negro	
664081	Derecho	Negro	
66407	Izquierdo	Blanco	
664071	Derecho	Blanco	



MANIJA SEGURO DE VENTANA WH6035			
Código 1	Lado	Color	
66410	Izquierdo	Negro	
664101	Derecho	Negro	
66409	Izquierdo	Blanco	
664091	Derecho	Blanco	



MANIJA VENTANA CON SEGURO BOTON WH6201B		
Código 1	Color	
66406	Negro	
66405	Blanco	



MANIJA DE PUERTA CON LLAVES WH6461B		
Código 1	Color	
664111	Negro	
66411	Blanco	

Todas las imágenes son referenciales al producto original



**CEDIMPORTSA S.A.**



@Cedimportsaec

**0997896093**

## CONTÁCTENOS

Parque Industrial Inmaconsa Calle  
A s/n y Tecas Guayaquil - Ecuador

(593) 04 2103782 - 04 2100048

[info@cedimportsa.com](mailto:info@cedimportsa.com)

[ventas@cedimportsa.com](mailto:ventas@cedimportsa.com)

[www.cedimportsa.com](http://www.cedimportsa.com)